

# JVC



## AUDIO/VIDEO CONTROL RECEIVER

RECEPTEUR DE CONTROL AUDIO/VIDEO

# RX-7010VBK

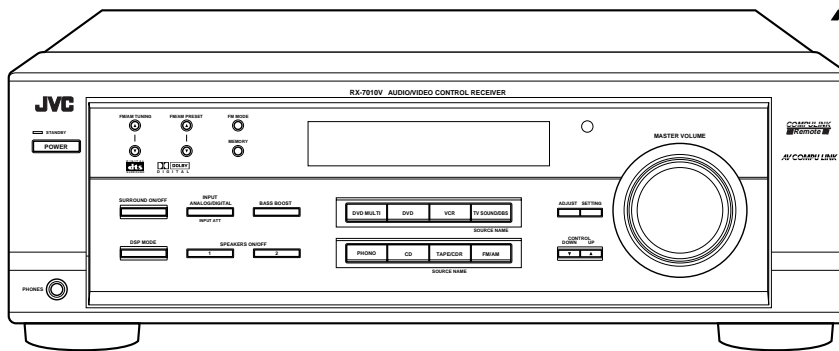
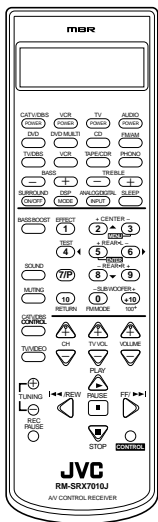

**AV COMPU LINK**

**COMPU LINK**  
Remote

DIGITAL  
**dts**  
SURROUND

**DOLBY**  
DIGITAL

## INSTRUCTIONS

MANUAL D'INSTRUCTIONS

**For Customer Use:**

Enter below the Model No. and Serial No. which are located either on the rear, bottom or side of the cabinet. Retain this information for future reference.

Model No. \_\_\_\_\_

Serial No. \_\_\_\_\_

LVT0579-002A

[C]

# Warnings, Cautions and Others/ Mises en garde, précautions et indications diverses

---

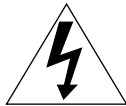

The lightning flash with arrowhead symbol, within an equilateral triangle is intended to alert the user to the presence of uninsulated "dangerous voltage" within the product's enclosure that may be of sufficient magnitude to constitute a risk of electric shock to persons.



The exclamation point within an equilateral triangle is intended to alert the user to the presence of important operating and maintenance (servicing) instructions in the literature accompanying the appliance.

**WARNING: TO REDUCE THE RISK OF FIRE OR ELECTRIC SHOCK, DO NOT EXPOSE THIS APPLIANCE TO RAIN OR MOISTURE.**

## CAUTION

To reduce the risk of electrical shocks, fire, etc.:

1. Do not remove screws, covers or cabinet.
2. Do not expose this appliance to rain or moisture.

## ATTENTION

Afin d'éviter tout risque d'électrocution, d'incendie, etc.:

1. Ne pas enlever les vis ni les panneaux et ne pas ouvrir le coffret de l'appareil.
2. Ne pas exposer l'appareil à la pluie ni à l'humidité.

## Caution — POWER switch!

Disconnect the mains plug to shut the power off completely. The POWER switch in any position does not disconnect the mains line. The power can be remote controlled.

## Attention — Commutateur POWER!

Déconnecter la fiche de secteur pour couper complètement le courant. Le commutateur POWER ne coupe jamais complètement la ligne de secteur, quelle que soit sa position. Le courant peut être télécommandé.

**For Canada/pour Le Canada**

THIS DIGITAL APPARATUS DOES NOT EXCEED THE CLASS B LIMITS FOR RADIO NOISE EMISSIONS FROM DIGITAL APPARATUS AS SET OUT IN THE INTERFERENCE-CAUSING EQUIPMENT STANDARD ENTITLED "DIGITAL APPARATUS," ICES-003 OF THE DEPARTMENT OF COMMUNICATIONS. CET APPAREIL NUMERIQUE RESPECTE LES LIMITES DE BRUITS RADIOELECTRIQUES APPLICABLES AUX APPAREILS NUMERIQUES DE CLASSE B PRESCRITES DANS LA NORME SUR LE MATERIEL BROUILLEUR; "APPAREILS NUMERIQUES", NMB-003 EDICTEE PAR LE MINISTRE DES COMMUNICATIONS.

**For Canada/pour le Canada**

**CAUTION:** TO PREVENT ELECTRIC SHOCK, MATCH WIDE BLADE OF PLUG TO WIDE SLOT, FULLY INSERT

**ATTENTION:** POUR EVITER LES CHOCS ELECTRIQUES, INTRODUIRE LA LAME LA PLUS LARGE DE LA FICHE DANS LA BORNE CORRESPONDANTE DE LA PRISE ET POUSSER JUSQU'AU FOND

**For U.S.A.**

This equipment has been tested and found to comply with the limits for a Class B digital device, pursuant to part 15 of the FCC Rules. These limits are designed to provide reasonable protection against harmful interference in a residential installation.

This equipment generates, uses and can radiate radio frequency energy and, if not installed and used in accordance with the instructions, may cause harmful interference to radio communications. However, there is no guarantee that interference will not occur in a particular installation. If this equipment does cause harmful interference to radio or television reception, which can be determined by turning the equipment off and on, the user is encouraged to try to correct the interference by one or more of the following measures:

Reorient or relocate the receiving antenna.

Increase the separation between the equipment and receiver.

Connect the equipment into an outlet on a circuit different from that to which the receiver is connected.

Consult the dealer or an experienced radio/TV technician for help.

**Caution: Proper Ventilation**

To avoid risk of electric shock and fire and to protect from damage.

Locate the apparatus as follows:

Front: No obstructions open spacing.

Sides: No obstructions in 10 cm from the sides.

Top: No obstructions in 10 cm from the top.

Back: No obstructions in 15 cm from the back

Bottom: No obstructions, place on the level surface.

In addition, maintain the best possible air circulation as illustrated.

**Attention: Ventilation Correcte**

Pour éviter les chocs électriques, l'incendie et tout autre dégât.

Disposer l'appareil en tenant compte des impératifs suivants

Avant: Rien ne doit gêner le dégagement

Flancs: Laisser 10 cm de dégagement latéral

Dessus: Laisser 10 cm de dégagement supérieur

Arrière: Laisser 15 cm de dégagement arrière

Dessous: Rien ne doit obstruer par dessous; poser l'appareil sur une surface plate.

Veiller également à ce que l'air circule le mieux possible comme illustré.

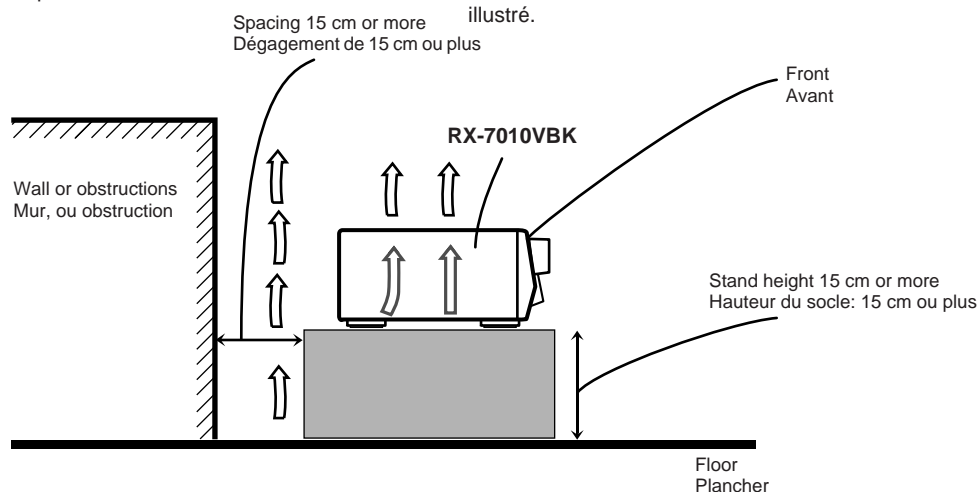

# Table of Contents

<b>Parts Identification .....</b>	<b>2</b>	<b>Using the DVD MULTI Playback Mode .....</b>	<b>27</b>
<b>Getting Started .....</b>	<b>3</b>	Activating the DVD MULTI Playback Mode .....	27
Before Installation .....	3	<b>COMPU LINK Remote Control System .....</b>	<b>28</b>
Checking the Supplied Accessories .....	3	<b>AV COMPU LINK Remote Control System ....</b>	<b>29</b>
Connecting the FM and AM Antennas .....	3	<b>Operating JVC's Audio/Video Components ...</b>	<b>31</b>
Connecting the Speakers .....	4	Operating Audio Components .....	31
Connecting Audio/Video Components .....	5	Operating Video Components .....	33
Connecting the Power Cord .....	9	<b>Operating Other Manufacturers' Video</b>	
Putting Batteries in the Remote Control .....	9	<b>Equipment .....</b>	<b>34</b>
<b>Basic Operations .....</b>	<b>10</b>	<b>Troubleshooting .....</b>	<b>38</b>
Turning the Power On and Off (Standby) .....	10	<b>Specifications .....</b>	<b>39</b>
Selecting the Source to Play .....	10		
Adjusting the Volume .....	11		
Selecting the Front Speakers .....	11		
Muting the Sound .....	12		
Reinforcing the Bass .....	12		
Adjusting the Tone .....	12		
Attenuating the Input Signal .....	12		
Adjusting the Subwoofer Output Level .....	12		
<b>Basic Settings .....</b>	<b>13</b>		
Recording a Source .....	13		
Adjusting the Front Speaker Output Balance .....	13		
Changing the Source Name .....	13		
Setting the Subwoofer Information .....	14		
Setting the Speakers for the DSP Modes .....	14		
Digital Input (DIGITAL IN) Terminal Setting .....	16		
Selecting the Analog or Digital Input Mode .....	16		
Storing the Basic Settings and Adjustments .....	17		
Using the Sleep Timer .....	17		
<b>Receiving Radio Broadcasts .....</b>	<b>18</b>		
Tuning in Stations Manually .....	18		
Using Preset Tuning .....	18		
Selecting the FM Reception Mode .....	19		
<b>Using the DSP Modes .....</b>	<b>20</b>		
What are the DSP Modes? .....	20		
Reproducing the Sound Field .....	21		
Available DSP Modes According to the Speaker Arrangement ..	22		
Adjusting the Surround Modes .....	23		
Adjusting the DAP Modes .....	25		
Activating the DSP Modes .....	26		

# Parts Identification

Become familiar with the buttons and controls on the receiver before use.  
Refer to the pages in parentheses for details.

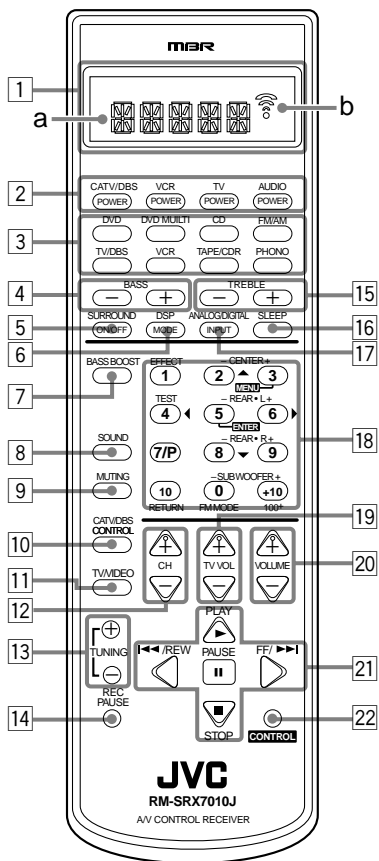
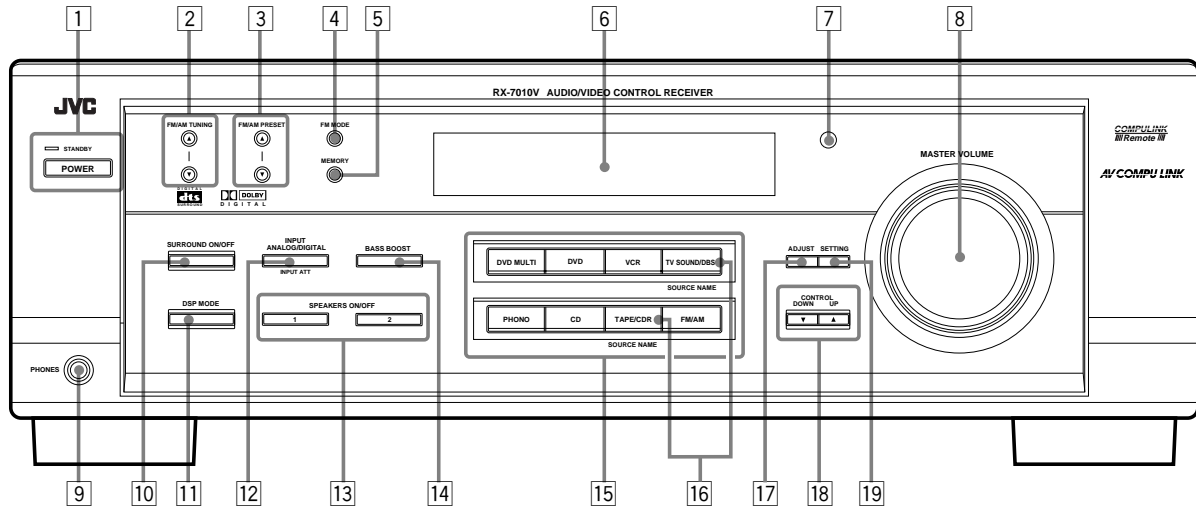

## Remote Control

- 1 Display window (See below) \*  
a: Remote control operation mode indicator  
b: Signal transmission indicator
- 2 Power buttons (10, 33 – 37)  
CATV/DBS, VCR, TV, AUDIO
- 3 Source selecting buttons (10, 17) \*  
DVD, DVD MULTI, CD, FM/AM, TV/DBS, VCR, TAPE/CDR, PHONO
- 4 BASS +/- buttons (12)
- 5 SURROUND ON/OFF button (22, 23, 26)
- 6 DSP MODE button (24 – 26)
- 7 BASS BOOST button (12)
- 8 SOUND button (12, 23 – 25, 27) \*
- 9 MUTING button (12)
- 10 CATV/DBS CONTROL button (35) \*
- 11 TV/VIDEO button (33, 34)
- 12 CH(annel) +/- buttons (33 – 36)
- 13 TUNING +/- buttons (18)
- 14 REC PAUSE button (32, 33, 36)
- 15 TREBLE +/- buttons (12)
- 16 SLEEP button (17)
- 17 ANALOG/DIGITAL INPUT button (17)
- 18 • 10 keys for selecting preset channels (19)  
• 10 keys for adjusting sound (12, 19, 23 – 25, 27)  
• 10 keys for operating audio/video components (31 – 37)
- 19 TV VOL(ume) +/- buttons (33, 34)
- 20 VOLUME +/- buttons (11)
- 21 Operating buttons for audio/video components (31 – 33, 36, 37)
- 22 CONTROL button (32, 33) \*

## Front Panel

- 1 POWER button and STANDBY lamp (10)
- 2 FM/AM TUNING ▲/▼ buttons (18)
- 3 FM/AM PRESET ▲/▼ buttons (18)
- 4 FM MODE button (19)
- 5 MEMORY button (18)
- 6 Display (10)
- 7 Remote sensor (9)
- 8 MASTER VOLUME control (11)
- 9 PHONES jack (11)
- 10 SURROUND ON/OFF button (22, 23, 26)
- 11 DSP MODE button (24 – 26)
- 12 INPUT ANALOG/DIGITAL button (17)
- 13 SPEAKERS ON/OFF 1 button (11)
- 14 SPEAKERS ON/OFF 2 button (11)
- 15 BASS BOOST button (12)
- 16 Source selecting buttons (10, 16)  
DVD MULTI, DVD, VCR, TV SOUND/DBS, PHONO, CD, TAPE/CDR, FM/AM  
• The TV SOUND/DBS button and TAPE/CDR button also function as the SOURCE NAME button.
- 17 ADJUST button (12, 13, 23 – 25, 27)
- 18 CONTROL UP ▲/DOWN ▼ buttons
- 19 SETTING button (14 – 16)

\* When you press one of these buttons, the remote control operation mode appears on the display window for about 10 seconds.

Ex.: When you press CD button

Buttons on the Remote Control	Remote Control Operation Mode	Buttons on the Remote Control	Remote Control Operation Mode
FM/AM	TUNER	TV/DBS	TV
CD	CD	VCR	VCR
PHONO	PHONO	CATV/DBS CONTROL	DBS
TAPE/CDR	TAPE	CONTROL	Current setting or VCR or TAPE or CDDSC
DVD	DVD	SOUND	SOUND
DVD MULTI	DVD		

# Getting Started

This section explains how to connect audio/video components and speakers to the receiver, and how to connect the power supply.

## Before Installation

### General

- Be sure your hands are dry.
- Turn the power off to all components.
- Read the manuals supplied with the components you are going to connect.

### Locations

- Install the receiver in a location that is level and protected from moisture.
- The temperature around the receiver must be between  $-5^{\circ}\text{C}$  and  $35^{\circ}\text{C}$  ( $23^{\circ}\text{F}$  and  $95^{\circ}\text{F}$ ).
- Make sure there is good ventilation around the receiver. Poor ventilation could cause overheating and damage the receiver.

### Handling the receiver

- Do not insert any metal object into the receiver.
- Do not disassemble the receiver or remove screws, covers, or cabinet.
- Do not expose the receiver to rain or moisture.

## Checking the Supplied Accessories

Check to be sure you have all of the following items, which are supplied with the receiver.

The number in the parentheses indicates quantity of the pieces supplied.

- Remote Control (1)
- Batteries (2)
- AM Loop Antenna (1)
- FM Antenna (1)

If anything is missing, contact your dealer immediately.

## Connecting the FM and AM Antennas

### FM Antenna Connections

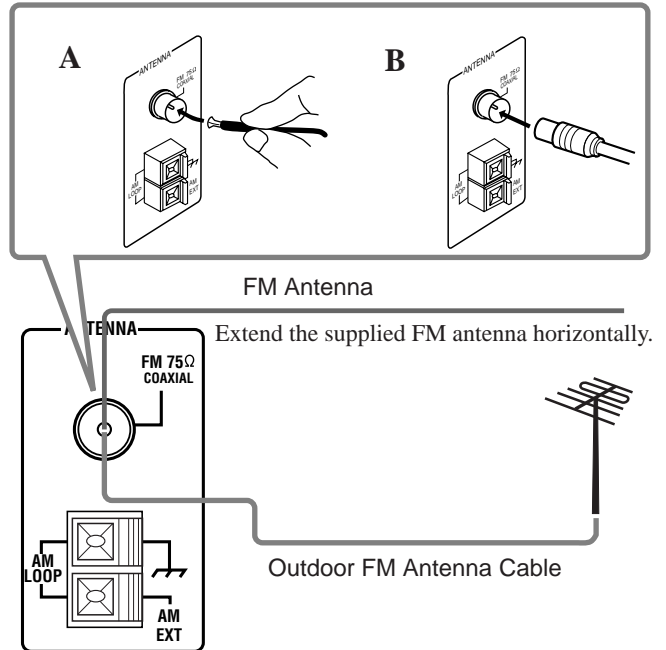

#### A. Using the Supplied FM Antenna

The FM antenna provided can be connected to the FM 75  $\Omega$  COAXIAL terminal as temporary measure.

#### B. Using the Standard Type Connector (Not Supplied)

A standard type connector should be connected to the FM 75  $\Omega$  COAXIAL terminal.

#### Note:

*If reception is poor, connect the outdoor antenna.*

*Before attaching a 75  $\Omega$  coaxial cable (the kind with a round wire going to an outdoor antenna), disconnect the supplied FM antenna.*

### AM Antenna Connections

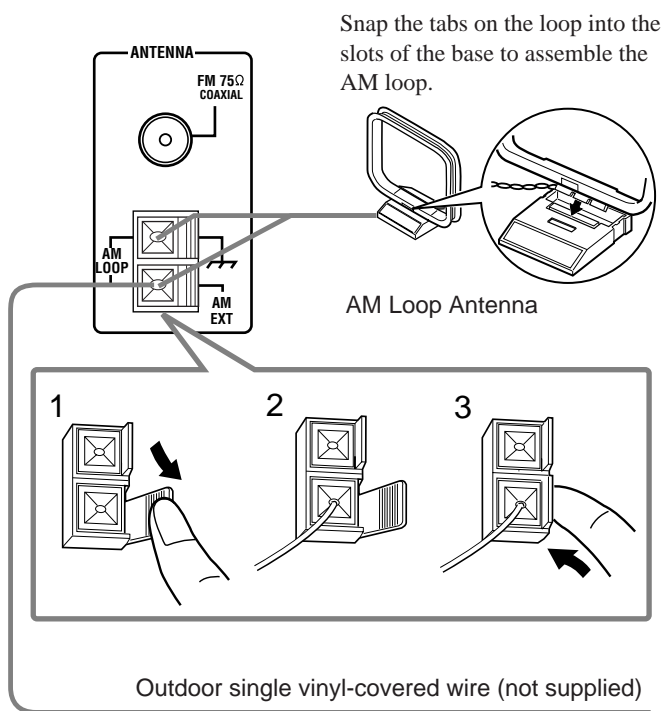

### Basic connecting procedure

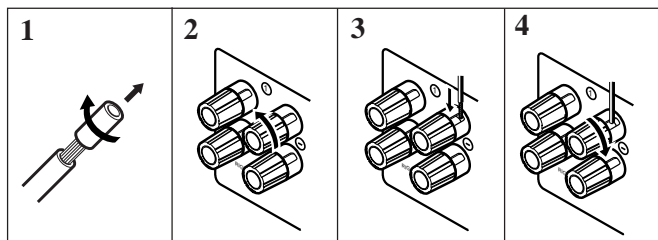

- 1 Cut, twist and remove the insulation at the end of each speaker signal cable (not supplied).
- 2 Turn the knob counterclockwise.
- 3 Insert the speaker signal cable.
- 4 Turn the knob clockwise.

### Connecting the front speakers

You can connect two pairs of front speakers (one pair to the FRONT SPEAKERS ① terminals, and another pair to the FRONT SPEAKERS ② terminals).

Turn the loop until you have the best reception.

#### Notes:

- If the AM loop antenna wire is covered with vinyl, remove the vinyl by twisting it as shown in the diagram.
- Make sure the antenna conductors do not touch any other terminals, connecting cords and power cord. This could cause poor reception.
- If reception is poor, connect an outdoor single vinyl-covered wire to the AM EXT terminal. (Keep the AM loop antenna connected.)

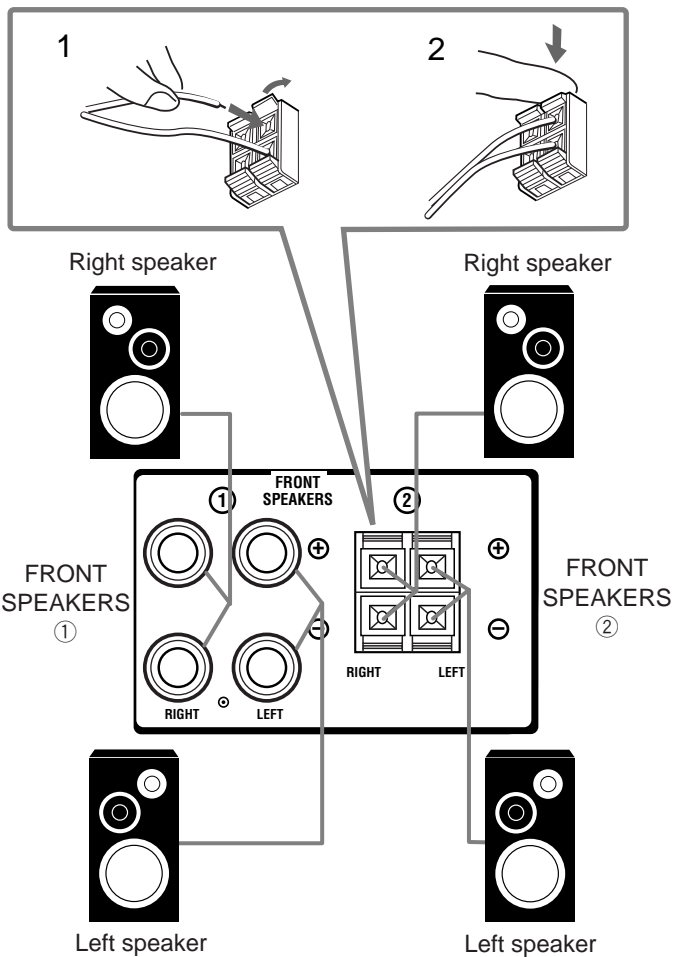

### Connecting the Speakers

You can connect the following speakers:

- Two pairs of front speakers to produce normal stereo sound.
- One pair of rear speakers to enjoy the surround effect.
- One center speaker to produce more effective surround effect (to emphasize human voices).
- One subwoofer to enhance the bass.

#### IMPORTANT:

After connecting the speakers listed above, set the speaker setting information properly to obtain the best possible DSP effect. For details, see page 14.

For each speaker (except for a subwoofer), connect the (+) and (-) terminals on the rear panel to the (+) and (-) terminals marked on the speakers. For connecting a subwoofer, see page 5.

#### CAUTION:

Use speakers with the SPEAKER IMPEDANCE indicated by the speaker terminals.

### About the speaker impedance

The required speaker impedance of the front speakers does differ depending on whether both the FRONT SPEAKERS ① and FRONT SPEAKERS ② terminals are used or only one of them is used.

**CASE 1** When you connect only one pair of front speakers

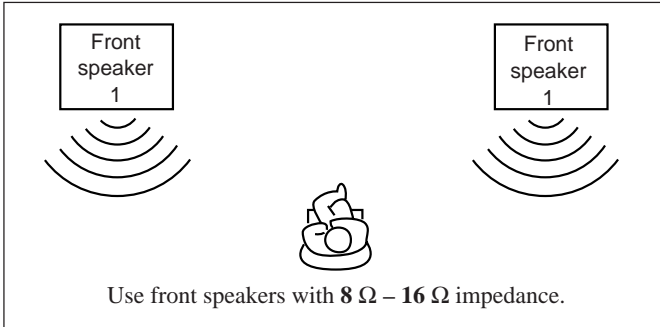

**CASE 2** When you connect two pairs of front speakers

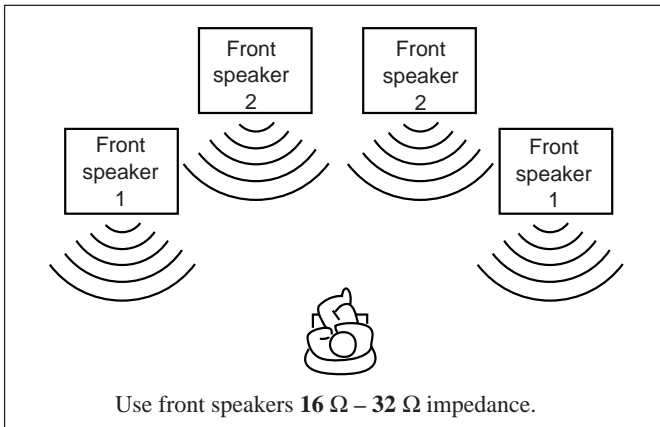

### Connecting the rear and center speakers

Connect rear speakers to the REAR SPEAKERS terminals and a center speaker to the CENTER SPEAKER terminals.

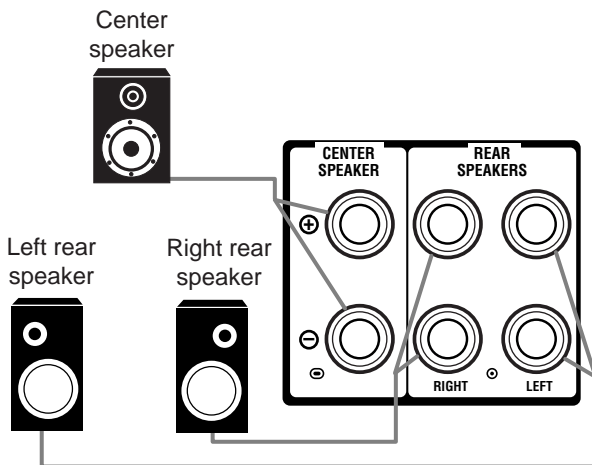

### Connecting the subwoofer speaker

You can enhance the bass by connecting a subwoofer. You can connect the input jack of a powered subwoofer to the SUBWOOFER OUT jack on the rear panel, using a cable with RCA pin plugs (not supplied).



### Connecting Audio/Video Components

You can connect the following audio/video components to this receiver. Refer also to the manuals supplied with your components.

Audio Components	Video Components
• Turntable	• DVD player*
• CD player*	• TV*
• Cassette deck or CD recorder*	• DBS tuner*
	• VCR

\* You can connect these components using the methods described in "Analog connections" (below) or in "Digital connections" (see page 8).

### Analog connections

#### Audio component connections

Use the cables with RCA pin plugs (not supplied). Connect the white plug to the audio left jack, and the red plug to the audio right jack.

**CAUTION:**

If you connect a sound-enhancing device such as a graphic equalizer between the source components and this receiver, the sound output through this receiver may be distorted.

**Turntable**

If an earth cable is provided for your turntable, connect the cable to the AM (⏏) terminal on the rear panel.

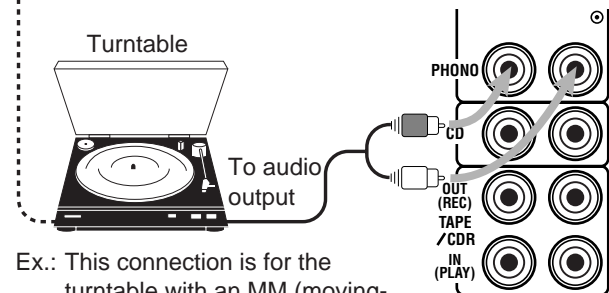

Ex.: This connection is for the turntable with an MM (moving-magnet) type cartridge.

**Note:**

Any turntables incorporating a small-output cartridge such as an MC (moving-coil) type must be connected to this receiver through a commercial head amplifier or step-up transformer. Direct connection may result in insufficient volume.



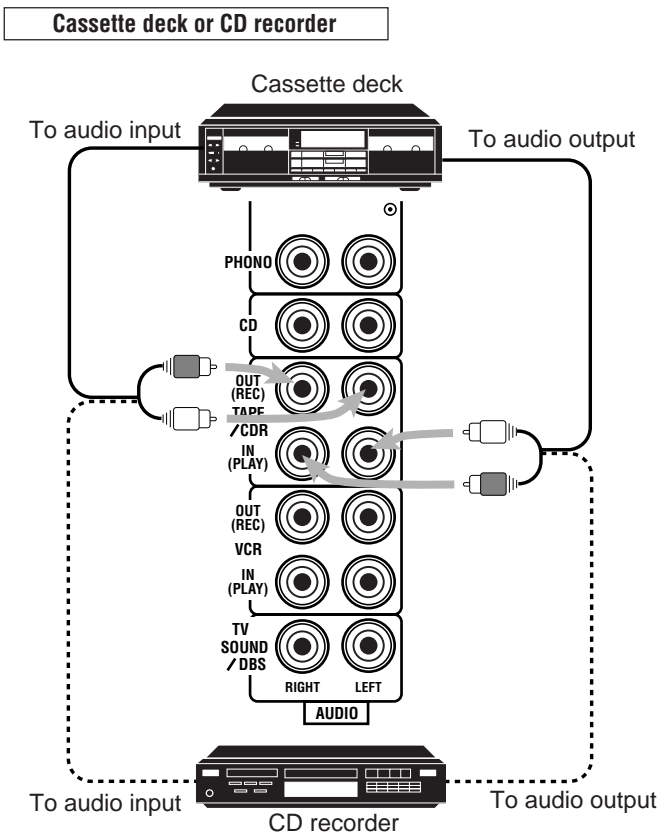
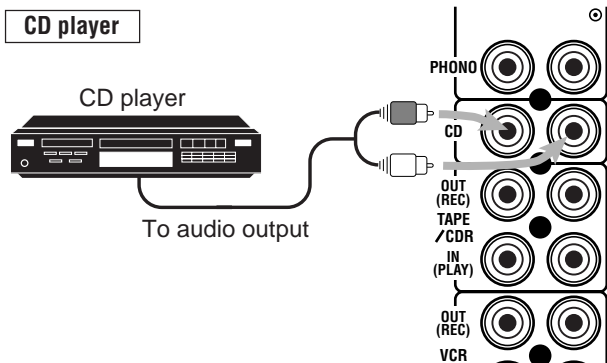

**Note:**

You can connect either a cassette deck or a CD recorder to the TAPE/CDR jacks. When connecting a CD recorder to the TAPE/CDR jacks, change the source name, which will be shown on the display when selected as the source, to "CDR." See page 13 for details.

**If your audio components have a COMPU LINK jack**

See also page 28 for detailed information about the connection and the COMPU LINK remote control system.

**Video component connections**

Use the cables with RCA pin plugs (not supplied). Connect the white plug to the audio left jack, the red plug to the audio right jack, and the yellow plug to the video jack. If your video components have S-video (Y/C-separation) terminals, connect them using S-video cables (not supplied). Connecting these video components through the S-video input/output terminals will give you better picture playback (or recording) quality.

**IMPORTANT:**

This receiver is equipped with both the composite video and S-video input/output terminals for connecting video components. You do not have to connect both the composite video and S-video terminals.

However, **remember that the video signals from the composite video input terminals are output only through the composite video output terminals, while the ones from the S-video input terminals are output only through the S-video output terminals.**

Therefore, if a recording video component and a playing video component are connected to the receiver through the different video terminals, you cannot record the picture from the playing component on the recording component. In addition, if the TV and a playing video component are connected to the receiver through the different video terminals, you cannot view the playback picture from the playing component on the TV.

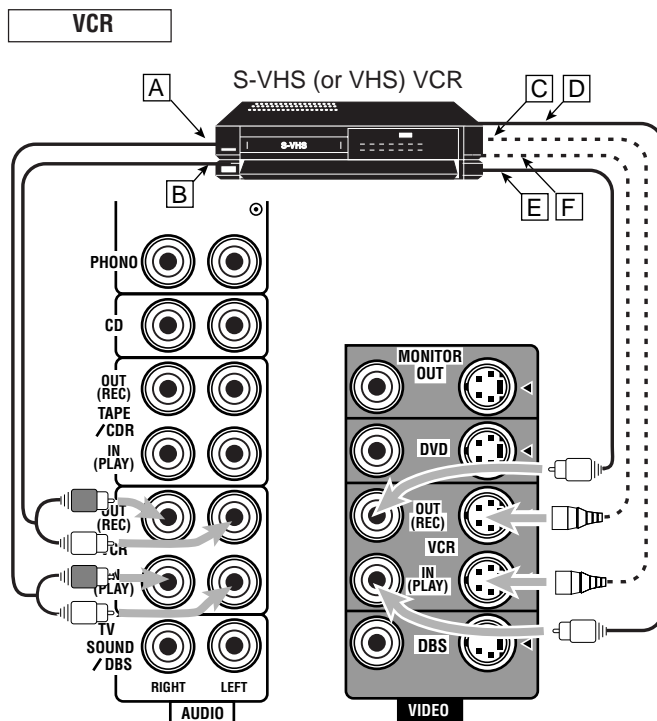

- A To left/right channel audio output
- B To left/right channel audio input
- C To S-video output
- D To composite video output
- E To composite video input
- F To S-video input

**TV and/or DBS tuner**

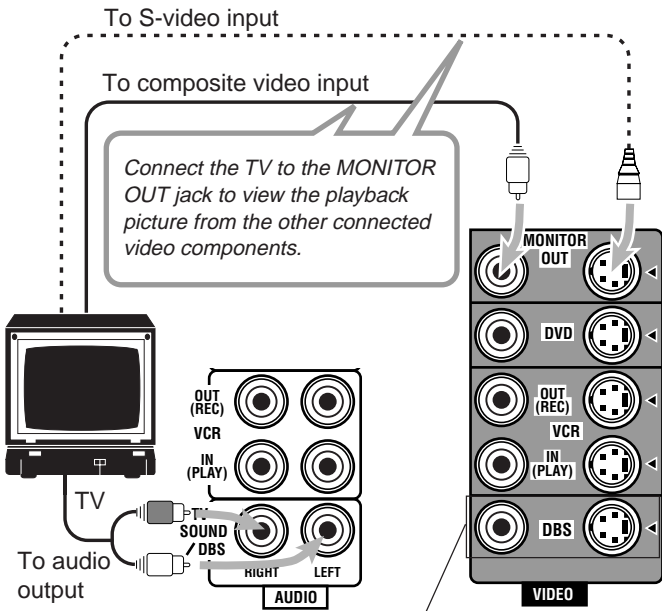

When connecting the TV to the AUDIO jacks (TV SOUND/DBS), DO NOT connect the TV's video output to these video input terminals.

**Note:**

When using AV COMPU LINK remote control system, you can only connect the TV with AV COMPU LINK EX to the AV COMPU LINK terminal. See page 29 for details.

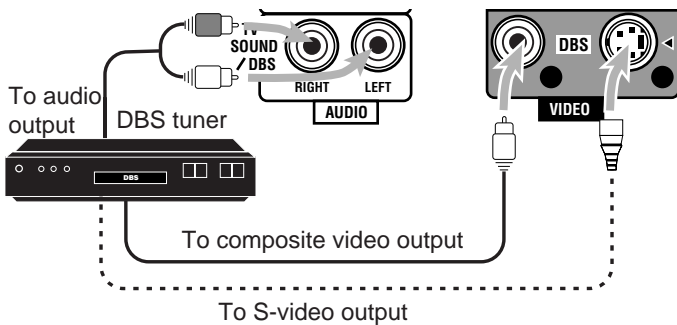

**Note:**

When connecting the DBS tuner to the TV SOUND/DBS jacks, change the source name, which will be shown on the display when selected as the source, to "DBS." See page 13 for details.

**DVD player**

- When you connect the DVD player with stereo output jacks:

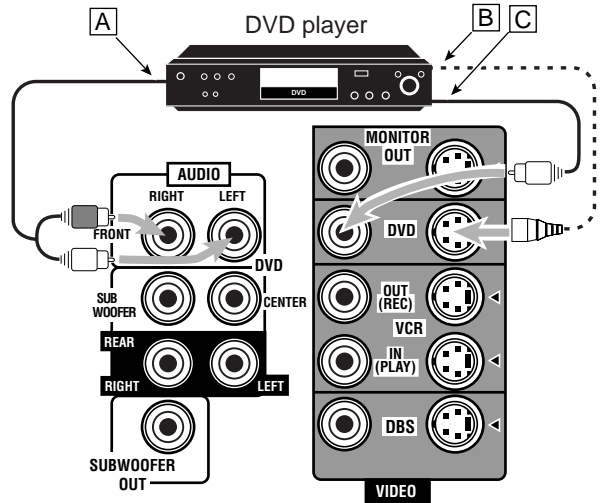

- A To front left/right channel audio output (or to audio mixed output if necessary)
- B To S-video output
- C To composite video output

- When you connect the DVD player with its analog discrete output (5.1 CH reproduction) jacks:

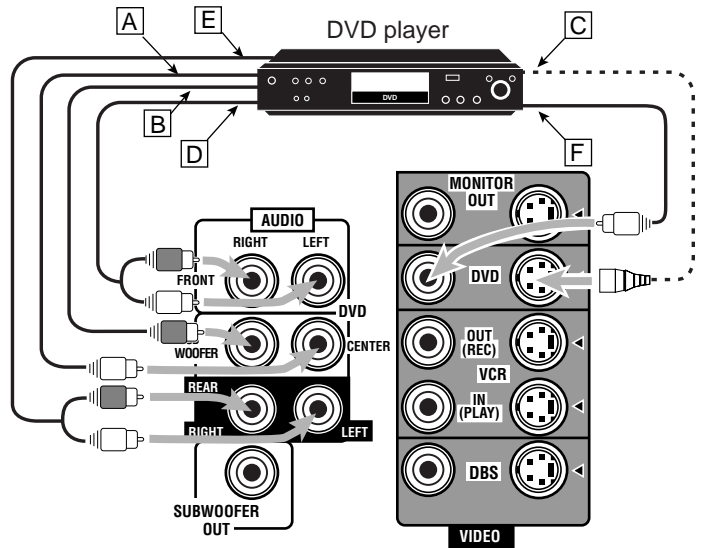

- A To center channel audio output
- B To subwoofer audio output
- C To S-video output
- D To front left/right channel audio output
- E To rear left/right channel audio output
- F To composite video output

## Digital connections

This receiver is equipped with four DIGITAL IN terminals — one digital coaxial terminal and three digital optical terminals, and one DIGITAL OUT terminal.

You can connect any digital equipment such as —

- DBS tuner,
- Digital TV broadcast tuner,
- DVD player,
- CD player, and
- CD recorder.

### IMPORTANT:

- When connecting the DVD player, digital TV broadcast tuner or DBS tuner using the digital terminals, you also need to connect it to the video jack (either composite video terminal or S-video terminal) on the rear. Without connecting it to the video jack, you can view no playback picture.
- After connecting the components using the DIGITAL IN terminals, set the following correctly if necessary.
  - Set the digital input (DIGITAL IN) terminal setting correctly. For details, see “Digital Input (DIGITAL IN) Terminal Setting” on page 16.
  - Select the digital input mode correctly. For details, see “Selecting the Analog or Digital Input Mode” on page 16.

### Digital input terminals

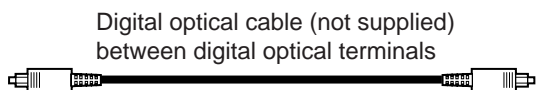
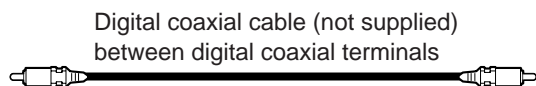
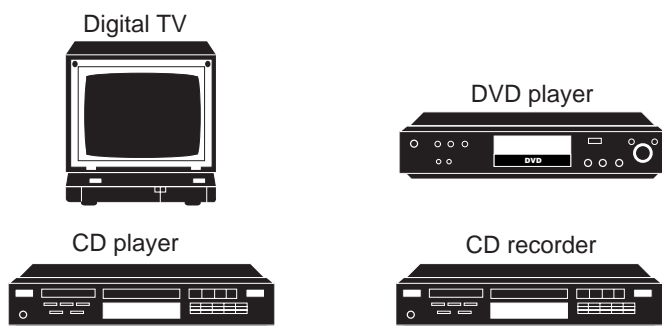

When the component has a digital coaxial output terminal, connect it to the DIGITAL 1 (DVD) terminal, using the digital coaxial cable (not supplied).

When the component has a digital optical output terminal, connect it to the DIGITAL 2 (CD), DIGITAL 3 (TV), or DIGITAL 4 (CDR) terminal, using the digital optical cable (not supplied).

Before connecting a digital optical cable, unplug the protective plug.

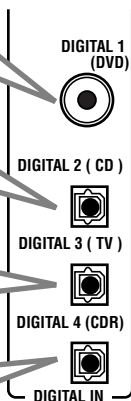
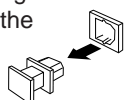

### Notes:

- When shipped from the factory, the DIGITAL IN terminals have been set for use with the following components.
  - DIGITAL 1 (coaxial): For DVD player
  - DIGITAL 2 (optical): For CD player
  - DIGITAL 3 (optical): For digital TV broadcast tuner
  - DIGITAL 4 (optical): For CD recorder
- When you want to operate the CD player or CD recorder using the COMPU LINK remote control system, connect the target component also as described in “Analog connections” (see page 6).
- When you want to operate the DVD player using the AV COMPU LINK remote control system, connect the DVD player also as described in “Analog connections” (see page 7).

### Digital output terminal

CD recorder, etc.



Digital optical cable (not supplied) between digital optical terminals



When the digital recording equipment such as a CD recorder has a digital optical input terminal, connecting it to the DIGITAL OUT terminal enables you to perform digital-to-digital recording.

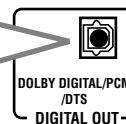

## Connecting the Power Cord

Before plugging the receiver into an AC outlet, make sure that all connections have been made.

**Plug the power cord into an AC outlet.**

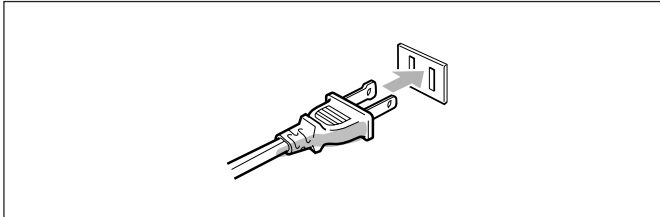

Keep the power cord away from the connecting cables and the antenna. The power cord may cause noise or screen interference. We recommend that you use a coaxial cable to connect the antenna, since it is well-shielded against interference.

### Note:

The preset settings such as preset channels and sound adjustment may be erased in a few days in the following cases:

- When you unplug the power cord.
- When a power failure occurs.

### CAUTIONS:

- Do not touch the power cord with wet hands.
- Do not pull on the power cord to unplug the cord. When unplugging the cord, always grasp the plug so as not to damage the cord.

## Putting Batteries in the Remote Control

Before using the remote control, put two supplied batteries first. When using the remote control, aim the remote control directly at the remote sensor on the receiver.

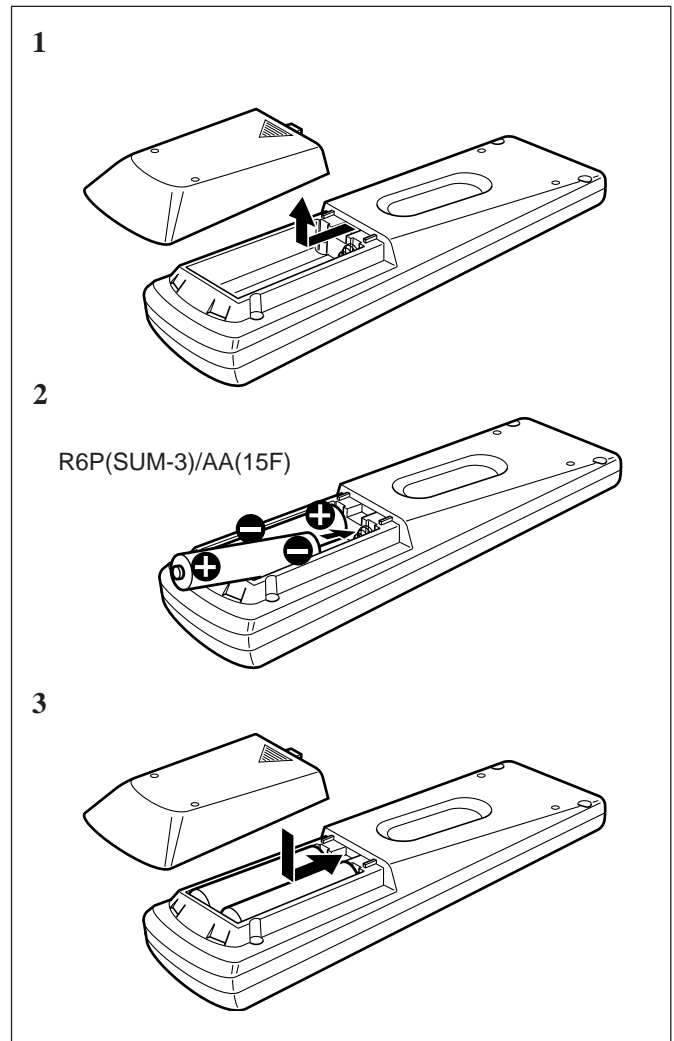

1. On the back of the remote control, remove the battery cover.
2. Insert batteries. Make sure to match the polarity: (+) to (+) and (-) to (-).
3. Replace the cover.

If the range or effectiveness of the remote control decreases, replace the batteries. Use two R6P(SUM-3)/AA(15F) type dry-cell batteries.

### CAUTION:

Follow these precautions to avoid leaking or cracking cells:

- Place batteries in the remote control so they match the polarity: (+) to (+) and (-) to (-).
- Use the correct type of batteries. Batteries that look similar may differ in voltage.
- Always replace both batteries at the same time.
- Do not expose batteries to heat or flame.

# Basic Operations

The following operations are commonly used when you play any sound source.

## Turning the Power On and Off (Standby)

### On the front panel:

To turn on the power, press POWER.

The STANDBY lamp goes off. The name of the current source (or station frequency) appears on the display.

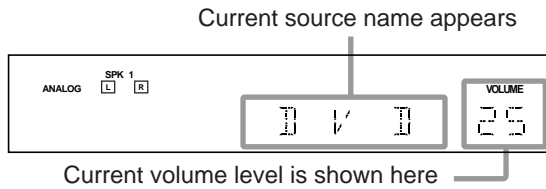
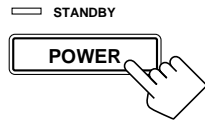

To turn off the power (into standby mode), press POWER again.

The STANDBY lamp lights up. A small amount of power is consumed in standby mode. To turn the power off completely, unplug the AC power cord.

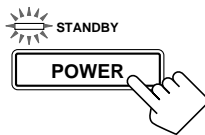

### From the remote control:

To turn on the power, press AUDIO POWER.

The STANDBY lamp goes off. The name of the current source (or station frequency) appears on the display.



To turn off the power (into standby mode), press AUDIO POWER again. The STANDBY lamp lights up.

## Selecting the Source to Play

Press one of the source selecting buttons.

### On the front panel:

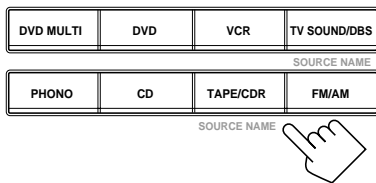

### From the remote control:

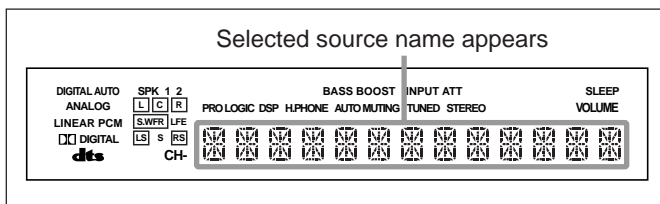
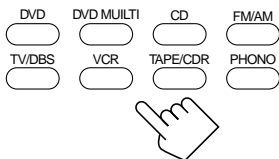

- DVD MULTI Select the DVD player for viewing the digital video disc using the analog discrete output mode (5.1 CH reproduction). To enjoy the DVD MULTI playback, see page 27.
- DVD Select the DVD player.
- VCR Select the video component connected to the VCR jacks.
- TV SOUND/DBS Select TV sounds (or the DBS tuner).
- PHONO \* Select the turntable.
- CD \* Select the CD player.
- TAPE/CDR \* Select the cassette deck (or the CD recorder).
- FM/AM \* Select an FM or AM broadcast.
  - Each time you press the button, the band alternates between FM and AM.

### Notes:

- When connecting a CD recorder (to the TAPE/CDR jacks), and a DBS tuner (to the TV SOUND/DBS jacks), change the source name shown on the display. For details, see page 13.
- When you press one of the source selecting buttons on the remote control marked above with an asterisk (\*), the receiver automatically turns on.

## Signal and speaker indicators on the display

The signal indicators light up in the following cases:

- Only the indicators for the incoming signals light up.
- When analog input is selected, "L" and "R" always light up.
- When "DVD MULTI" is selected as the source, "L," "C," "R," "LFE," "LS" and "RS" light up.

The speaker indicators light up only —:

- When the corresponding speaker is activated.

### AND

- When the corresponding speaker is required for the DSP mode selected currently.

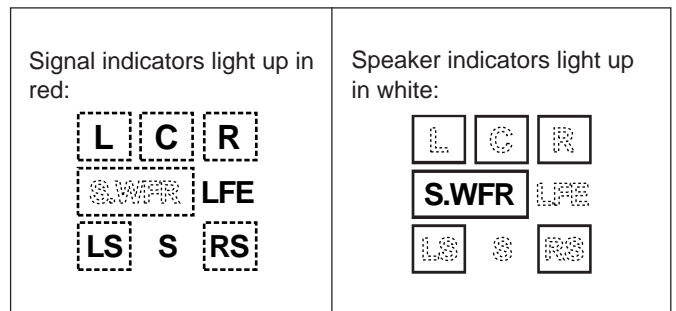

- L:
  - When digital input is selected: Lights up when the left channel signal comes in.
  - When analog input is selected: Always lights up.
- R:
  - When digital input is selected: Lights up when the right channel signal comes in.
  - When analog input is selected: Always lights up.
- C: Lights up when the center channel signal comes in.
- LS: Lights up when the left rear channel signal comes in.
- RS: Lights up when the right rear channel signal comes in.
- S: Lights up when the monaural rear channel signal comes in.
- LFE: Lights up when the LFE channel signal comes in.

### Notes:

- When "SUBWOOFER" is set to "YES," [S.WFR] lights up.
- When you select "DVD MULTI," all the signal indicators except "S" light up.

## Selecting different sources for picture and sound

You can watch picture from a video component while listening to sound from another component.

Press one of the audio source selecting buttons — PHONO, CD, TAPE/CDR, FM/AM, TV SOUND/DBS\* (or TV/DBS on the remote control), while viewing the picture from a video component such as the VCR, DVD player, or DBS tuner, etc.

### Notes:

- Once you have selected a video source, pictures of the selected source are sent to the TV until you select another video source.
- \* The TV SOUND/DBS (or TV/DBS on the remote control) only works for selecting "DBS" as the source but not for selecting "TV SOUND (or TV on the remote control)." When you use the DBS tuner, change the source name correctly (see page 13).

## Adjusting the Volume

### On the front panel:

To increase the volume, turn MASTER VOLUME clockwise.

To decrease the volume, turn it counterclockwise.

- When you turn MASTER VOLUME rapidly, the volume level also changes rapidly.
- When you turn MASTER VOLUME slowly, the volume level also changes slowly.

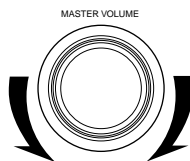

### From the remote control:

To increase the volume, press VOLUME +.

To decrease the volume, press VOLUME -.

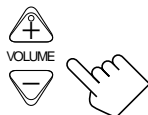

### CAUTION:

Always set the volume to the minimum before starting any source. If the volume is set at its high level, the sudden blast of sound energy can permanently damage your hearing and/or ruin your speakers.

### Note:

The volume level can be adjusted within the range of "0" (minimum) to "80" (maximum).

## Selecting the Front Speakers

### On the front panel ONLY:

When you have connected two pairs of the front speakers, you can select which to use.

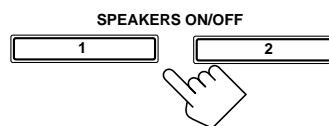

To use the speakers connected to the FRONT SPEAKERS ① terminals, press SPEAKERS ON/OFF 1 so that the SPK 1 indicator lights up on the display. (Make sure that the SPK 2 is not on the display.)

To use the speakers connected to the FRONT SPEAKERS ② terminals, press SPEAKERS ON/OFF 2 so that the SPK 2 indicator lights up on the display. (Make sure that the SPK 1 is not on the display.)

To use both sets of the speakers, press SPEAKERS ON/OFF 1 and 2 so that the SPK 1 and SPK 2 indicators light up on the display.

To use neither sets of the speakers, press SPEAKERS ON/OFF 1 and 2 so that the SPK 1 and SPK 2 indicators disappear from the display.

### Notes:

- If you select any of the DSP modes while using both the speakers connected to the FRONT SPEAKERS ① and ② terminals, the speakers connected to the FRONT SPEAKERS ② terminals are deactivated.
- While the DSP MODE is in use, you can only select either the speakers connected to the FRONT SPEAKERS ① or ② terminals.

### Listening only with headphones

You must turn off both pairs of speakers when you listen with headphones.

1. Connect a pair of headphones to the PHONES jack on the front panel.
2. Press SPEAKERS ON/OFF 1 and SPEAKERS ON/OFF 2 so that neither the SPK 1 nor SPK 2 indicator appears on the display.

This cancels the DSP mode currently selected, and activates the HEADPHONE mode (see below).

- "HEADPHONE" appears and H. PHONE indicator lights up on the display.

### HEADPHONE mode:

This mode can reproduce the LFE channel signals, mixing them with the front channel signals. So you will not miss the subwoofer sounds even if you listen to a source using the headphones.

### Notes:

- While in the HEADPHONE mode, you cannot use any DSP modes (see page 20.)
- Activating the speaker cancels the HEADPHONE mode and turns on the DSP mode previously selected.

### CAUTION:

Be sure to turn down the volume before connecting or putting on headphones, as high volume can damage both the headphones and your hearing.

## Muting the Sound

### From the remote control ONLY:

Press **MUTING** to mute the sound through all speakers and headphones connected.



“MUTING” appears on the display and the volume turns off (the volume level indicator goes off).

To restore the sound, press **MUTING** again so that “OFF” appears on the display.

- Turning **MASTER VOLUME** on the front panel or pressing **VOLUME +/-** on the remote control also restores the sound.

## Reinforcing the Bass

You can boost the bass level.

Press **BASS BOOST** on the front panel or on the remote control to select the bass boost function.

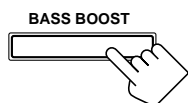

On the front panel



On the remote control

- Each time you press the button, the bass boost function turns on (“BASSBOOST ON”) and off (“BASSBOOST OFF”).
- Select “BASSBOOST ON” to activate the bass boost function. The **BASS BOOST** indicator lights up on the display.
- Select “BASSBOOST OFF” to cancel it. The indicator goes off.

### Note:

This function affects the front speaker sounds only.

## Adjusting the Tone

You can adjust the bass and treble sounds as you like.

### Before you start, remember...

- There is a time limit in doing the following steps. If the setting is canceled before you finish, start from step 1 again.

### On the front panel:

- Press **ADJUST** repeatedly until “**BASS**” or “**TREBLE**” appears on the display.

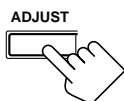

- Select “**BASS**” to adjust the bass sound level.
- Select “**TREBLE**” to adjust the treble sound level.

- Press **CONTROL UP ▲/DOWN ▼** to adjust the bass or treble sound level (+10 dB to -10 dB).

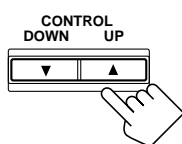

- Each time you press the button, the sound level changes by  $\pm 2$  steps.

### From the remote control:

Press **BASS +/-** or **TREBLE +/-** to adjust the bass or treble sound level (+10 dB to -10 dB).

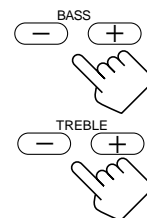

## Attenuating the Input Signal

When the input level of the playing source is too high, the sounds will be distorted. If this happens, you need to attenuate the input signal level to prevent the sound distortion.

### On the front panel ONLY:

Press and hold **INPUT ATT** so that the **INPUT ATT** indicator lights up on the display.

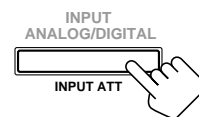

- Each time you press and hold the button, the Input Attenuator mode turns on (“**INPUT ATT ON**”) or off (“**INPUT NORMAL**”).

### Notes:

- This function is available only for the sources connected using the analog terminals.
- This function takes effect when the DSP mode is in use.
- When selecting “**DVD MULTI**” as the source, this effect does not work.

## Adjusting the Subwoofer Output Level

You can adjust the subwoofer output level if you have selected “**YES**” for the “**SUBWOOFER**” (see page 14). Once it has been adjusted, the receiver memorizes the adjustment.

### Before you start, remember...

- There is a time limit in doing the following steps. If the setting is canceled before you finish, start from step 1 again.
- When the front speakers are all deactivated, the subwoofer level cannot be adjusted.

### On the front panel:

- Press **ADJUST** repeatedly until “**SUBWFR LEVEL**” appears on the display.

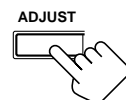

The display changes to show the current setting.

- Press **CONTROL UP ▲/DOWN ▼** to adjust the subwoofer output level (+10 dB to -10 dB).

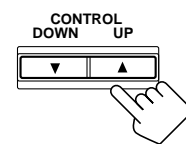

### From the remote control:

- Press **SOUND**.  
The 10 keys are activated for sound adjustments.
- Press **SUBWOOFER +/-** to adjust the subwoofer output level (+10 dB to -10 dB).

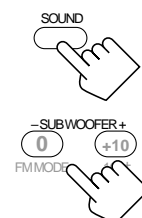

# Basic Settings

Some of the following settings are required after connecting and positioning your speakers in your listening room, while others will make operations easier.

## Recording a Source

### For analog-to-analog recording

You can record any analog source through the receiver to —

- the cassette deck (or CD recorder) connected to the TAPE/CDR jacks, and
  - the VCR connected to the VCR jacks
- at the same time.

### For digital-to-digital recording

You can record the currently selected digital input through the receiver to a digital recording device connected to the DIGITAL OUT terminal.

#### Notes:

- Analog-to-digital and digital-to-analog recordings are not possible.
- The output volume level, bass boost (see page 12), tone adjustment (see page 12), and DSP modes (see page 20) cannot affect the recording.
- The test tone signal (see pages 23 and 24) does not come out through the DIGITAL OUT terminal.

## Adjusting the Front Speaker Output Balance

If the sounds you hear from the front right and left speakers are unequal, you can adjust the speaker output balance.

### Before you start, remember...

- There is a time limit in doing the following steps. If the setting is canceled before you finish, start from step 1 again.

#### On the front panel ONLY:

1. Press **ADJUST** repeatedly until “L/R BALANCE” appears on the display.

The display changes to show the current setting.

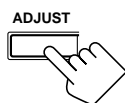

2. Press **CONTROL UP ▲/DOWN ▼** to adjust the balance.

- Pressing **CONTROL UP ▲** decreases the left channel output from CNTR (Center) to -21.
- Pressing **CONTROL DOWN ▼** decreases the right channel output from CNTR (Center) to -21.

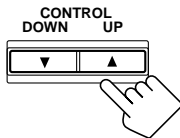

## Changing the Source Name

When you have connected a CD recorder to the TAPE/CDR jacks or the DBS tuner to the TV SOUND/DBS jacks on the rear panel, change the source name which will be shown on the display when you select the CD recorder or DBS tuner as the source.

#### On the front panel ONLY:

When changing the source name from “TAPE” to “CDR”:

- Press and hold **TAPE/CDR/SOURCE NAME** to assign “CDR.”

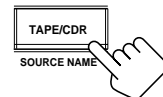

When changing the source name from “TV SOUND” to “DBS”:

- Press and hold **TV SOUND/DBS/SOURCE NAME** to assign “DBS.”

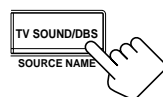

To change the source name to “TAPE” or “TV SOUND,” repeat the same procedure above — press and hold TAPE/CDR/SOURCE NAME to select “TAPE” or TV SOUND/DBS/SOURCE NAME to select “TV SOUND.”

#### Note:

Without changing the source name, you can still use the connected components. However, there may be some inconvenience.

- “TAPE” or “TV SOUND” will appear on the display when you select the CD recorder or DBS tuner.
- You cannot use the digital input (see page 16) for the CD recorder.
- You cannot use the COMPU LINK remote control system (see page 28) to operate the CD recorder.



## Setting the Subwoofer Information

Register whether you have connected a subwoofer or not.

**Before you start, remember....**

- There is a time limit in doing the following steps. If the setting is canceled before you finish, start from step 1 again.

**On the front panel ONLY:**

1. Press **SETTING** repeatedly until “**SUBWOOFER**” appears on the display.

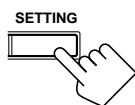

The display changes to show the current setting.

2. Press **CONTROL UP ▲/DOWN ▼** to register whether you have connected a subwoofer or not.

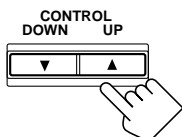

- Each time you press the button, the subwoofer setting alternates between “YES” and “NO.”

**YES:** Select this when a subwoofer is used. [S.WFR] lights up on the display (see page 10.)

**NO:** Select this when no subwoofer is used.

## Setting the Speakers for the DSP Modes

To obtain the best possible surround sound of the DSP modes, you have to register the information about the speakers arrangement after all connections are completed.

**Before you start, remember....**

- There is a time limit in doing the following steps. If the setting is canceled before you finish, start from step 1 again.

### Front, Center, and Rear Speaker Setting

Register the sizes of all the connected speakers.

- When you change your speakers, you need to register the information about the speakers again.

**On the front panel ONLY:**

1. Press **SETTING** repeatedly until “**FRONT SPK**” (Front Speaker), “**CENTER SPK**” (Center Speaker) or “**REAR SPK**” (Rear Speaker) appears on the display.

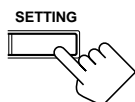

The display changes to show the current setting.

2. Press **CONTROL UP ▲/DOWN ▼** to select the appropriate item about the speaker selected in the above step.

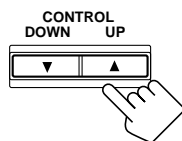

- Each time you press the button, the display changes to show the following:

→ LARGE ↔ SMALL ↔ NO ←

**LARGE:** Select this when the speaker size is relatively large.

**SMALL:** Select this when the speaker size is relatively small.

**NO:** Select this when you have not connected a speaker. (Not selectable for the front speakers)

3. Repeat steps 1 and 2 to select the appropriate items for the other speakers.

**Notes:**

- Keep the following comment in mind as reference when adjusting.
  - If the size of the cone speaker unit built in your speaker is greater than 4 3/4 inches (12 cm), select “LARGE,” and if it is smaller than 4 3/4 inches (12 cm), select “SMALL.”
- If you have selected “NO” for the subwoofer setting, you can only select “LARGE” for the front speaker setting.
- If you have selected “SMALL” for the front speaker setting, you cannot select “LARGE” for the center and rear speaker settings.

### Center Delay Time Setting

Register the delay time of the sound from the center speaker, comparing to that of the sound from the front speakers.

If the distance from your listening point to the center speaker is equal to that to the front speakers, select 0 msec. As the distance to the center speaker becomes shorter, the delay time increases.

- 1 msec increase (or decrease) in delay time corresponds to 11 13/16 inches (30 cm) decrease (or increase) in distance.
- When shipped from the factory, delay time is set to 0 msec.

**On the front panel ONLY:**

1. Press **SETTING** repeatedly until “**CENTER DELAY**” appears on the display.

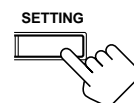

The display changes to show the current setting.

2. Press **CONTROL UP ▲/DOWN ▼** to select the delay time of the center speaker output.

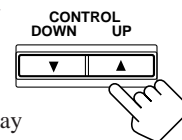

- Press **CONTROL UP ▲** to increase the delay time from 0 msec (“C\_DELAY 0MS”) to 5 msec (“C\_DELAY 5MS”).
- Press **CONTROL DOWN ▼** to decrease the delay time from 5 msec (“C\_DELAY 5MS”) to 0 msec (“C\_DELAY 0MS”).

**Notes:**

- Center delay time is not valid for the DVD MULTI playback mode.
- You cannot adjust the center delay time when you have set “CENTER SPK” to “NO.”

### Rear Delay Time Setting

Register the delay time of the sound from the rear speakers, comparing to that of the sound from the front speakers.

If the distance from your listening point to the rear speakers is equal to that to the front speakers, select 0 msec. As the distance to the rear speakers becomes shorter, the delay time increases.

- 1 msec increase (or decrease) in delay time corresponds to 11 13/16 inches (30 cm) decrease (or increase) in distance.
- Rear delay time for Dolby Digital and DTS Digital Surround is to be set to 5 msec.
- When shipped from the factory, delay time is set to 5 msec.

**On the front panel ONLY:**

1. Press **SETTING** repeatedly until “**REAR DELAY**” appears on the display.

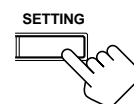

The display changes to show the current setting.

Continued to the next page.

## 2. Press CONTROL UP ▲/DOWN ▼ to select the delay time of the rear speaker output.

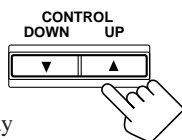

- Press CONTROL UP ▲ to increase the delay time from 0 msec (“R\_DELAY 0MS”) to 15 msec (“R\_DELAY 15MS”).
- Press CONTROL DOWN ▼ to decrease the delay time from 15 msec (“R\_DELAY 15MS”) to 0 msec (“R\_DELAY 0MS”).

### Notes:

- Rear delay time is not valid for the DVD MULTI playback mode.
- You cannot adjust the rear delay time when you have set “REAR SPK” to “NO.”

## Crossover Frequency Setting

Small speakers cannot reproduce the bass sound very well. So, if you have used a small speaker for any of the front, center, and rear channels, this receiver automatically reallocate the bass elements, originally assigned to the channel for which you have connected the small speaker, to another channel (for which you have connected the large speaker).

To use this function properly, you need to set the crossover frequency level according to the size of the small speaker connected.

- If you have selected “LARGE” for all speakers (see page 14), this function is set to “OFF” and cannot be adjusted.

### On the front panel ONLY:

#### 1. Press SETTING repeatedly until “CROSSOVER FRQ” (Crossover Frequency) appears on the display.

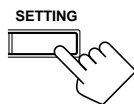

The display changes to show the current setting.

#### 2. Press CONTROL UP ▲/DOWN ▼ to select the crossover frequency level according to the size of the small speaker connected.

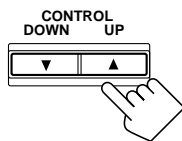

- Each time you press the button, the display changes to show the following:

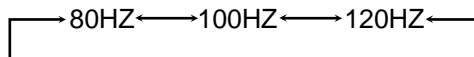

- Use the following comments as reference when adjusting.

**80HZ:** Select this when the cone speaker unit built in the speaker is about 4 <sup>3</sup>/<sub>4</sub> inches (12 cm).

**100HZ:** Select this when the cone speaker unit built in the speaker is about 3 <sup>15</sup>/<sub>16</sub> inches (10 cm).

**120HZ:** Select this when the cone speaker unit built in the speaker is about 3 <sup>3</sup>/<sub>16</sub> inches (8 cm).

### Note:

Crossover frequency is not valid for the DVD MULTI playback mode and HEADPHONE mode.

## Low Frequency Effect Attenuator Setting

If the bass sound is distorted while playing back a source using Dolby Digital or DTS Digital Surround, follow the procedure below.

### On the front panel ONLY:

#### 1. Press SETTING repeatedly until “LFE ATT” (Low Frequency Effect Attenuator) appears on the display.

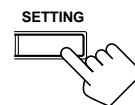

The display changes to show the current setting.

#### 2. Press CONTROL UP ▲/DOWN ▼ to select the low frequency effect attenuator level.

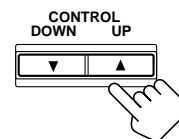

- Each time you press the button, the display changes to show the following:

0dB ←→ 10dB

**0dB:** Normally select this.

**10dB:** Select this when the bass sound is distorted.

### Notes:

- Low frequency effect attenuator is not valid for the DVD MULTI playback mode.
- This function takes effect only when the subwoofer (LFE) signals come in, (with “SUBWOOFER” set to “YES.”)

## Dynamic Range Compression Setting

You can compress the dynamic range (difference between maximum sound and minimum sound) of the reproduced sound. This is useful when enjoying surround sound at night.

- This function takes effect only when playing back a source using Dolby Digital.

### On the front panel ONLY:

#### 1. Press SETTING repeatedly until “D\_RANGE COMP” (Dynamic Range Compression) appears on the display.

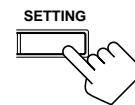

The display changes to show the current setting.

#### 2. Press CONTROL UP ▲/DOWN ▼ to select the appropriate item about the compression level.

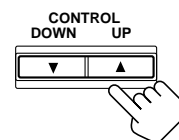

- Each time you press the button, the display changes to show the following:

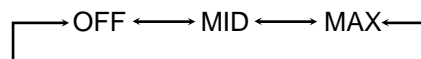

**OFF:** Select this when you want to enjoy surround with its full dynamic range. (No effect applied.)

**MID:** Select this when you want to reduce the dynamic range a little. (Factory setting.)

**MAX:** Select this when you want to apply the compression effect fully. (Useful at night.)

### Note:

Dynamic Range Compression is not valid for the DTS Digital Surround and DVD MULTI playback mode.

## Digital Input (DIGITAL IN) Terminal Setting

When you use the digital input terminals, you have to register what components are connected to which terminals (DIGITAL IN 1/2/3/4).

### Before you start, remember...

- There is a time limit in doing the following steps. If the setting is canceled before you finish, start from step 1 again.

### On the front panel ONLY:

#### To set the DIGITAL 1 terminal

1. Press **SETTING** repeatedly until “COAX DIG IN” appears on the display.

The display changes to show the current setting.

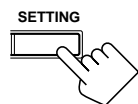

2. Press **CONTROL UP ▲/DOWN ▼** to select the appropriate digital terminal setting.

- Each time you press the button, the display changes to show the following:

1 DVD ⇄ 1 CDR ⇄ 1 TV (or 1 DBS\*) ⇄ 1 CD ⇄  
(back to the beginning)

\* If you have changed the source name from “TV SOUND” to “DBS,” “DBS” appears (see page 13.)

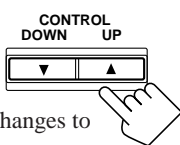

When the **DIGITAL 1** terminal is set, the **DIGITAL 2/3/4** terminal is automatically set as follows:

DIGITAL 3 terminal setting



DIGITAL 2 terminal setting

DIGITAL 4 terminal setting

When the **DIGITAL 1** is set to “DVD”

2 CD 3 TV (or DBS\*) 4 CDR

When the **DIGITAL 1** is set to “CDR”

2 DVD 3 CD 4 TV (or DBS\*)

When the **DIGITAL 1** is set to “TV” or “DBS”

2 DVD 3 CD 4 CDR

When the **DIGITAL 1** is set to “CD”

2 DVD 3 TV (or DBS\*) 4 CDR

\* If you have changed the source name from “TV SOUND” to “DBS,” “DBS” appears (see page 13.)

### Notes:

- When shipped from the factory, the DIGITAL IN terminals can be used as the digital input for the following components.
  - DIGITAL 1 (coaxial): For DVD player
  - DIGITAL 2 (optical): For CD player
  - DIGITAL 3 (optical): For digital TV broadcast tuner
  - DIGITAL 4 (optical): For CDR
- When using the DIGITAL 4 terminal for the CD recorder, you need to select “CDR” as the source name. (See page 13.)

## Selecting the Analog or Digital Input Mode

When you have connected digital source components, you need to select the input mode correctly according to the connection you made.

### Before you start, remember...

- The digital input (**DIGITAL IN**) terminal setting should be correctly done for the sources you want to select the digital input mode for. Without setting this digital input terminal correctly, you cannot change the input mode from analog input to digital input even if you follow the procedure below.

### On the front panel:

1. Press one of the source selecting buttons (DVD, TV SOUND/DBS, CD, or TAPE/CDR)\* for which you want to change the input mode.

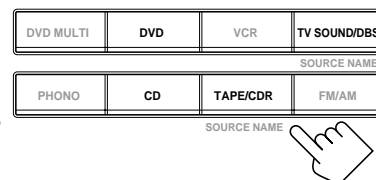

### Note:

\* Among the sources listed above, you can select the digital input only for the sources which you have selected the digital input terminals for. (See “Digital Input (DIGITAL IN) Terminal Setting.”)

2. Press **INPUT ANALOG/DIGITAL** to change the input mode.

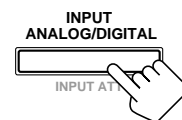

- Each time you press the button, the input mode changes as follows:

AUTO ←→ ANALOG  
(Digital)

**AUTO:** Select this for the digital input mode. The receiver automatically detects the incoming signal format. (The DIGITAL AUTO indicator lights up on the display, and the digital signal indicator for the detected signals also light up.)\*

**ANALOG:** Select this for the analog input mode.

\* The followings are the analog/digital signal indicators on the display to indicate what type of the signal comes into the receiver.

**DIGITAL AUTO :** Lights up when “AUTO” is selected as the digital input mode.

**ANALOG :** Lights up when the analog input is selected.

**LINEAR PCM :** Lights up when Linear PCM signals come in.

**DIGITAL:** Lights up when Dolby Digital signals come in.

**dts :** Lights up when DTS Digital Surround signals come in.

Continued to the next page.

When playing a software encoded with the DTS Digital Surround, "AUTO" may not work properly and the following symptoms may occur:

- Sound does not come out at the beginning of playback.
- Noise comes out while using the searching or skipping function.

In this case, press CONTROL UP ▲/DOWN ▼ to select "DTS" while "AUTO" is lit on the display.

- Each time you press the button, the input mode changes as follows:

AUTO (Digital) ←→ DTS (Digital)

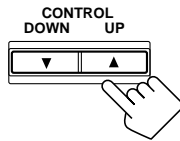

**Note:**

When you turn off the power or select another source, "DTS" setting is canceled and the digital input mode is automatically reset to "AUTO."

To change the input mode back to analog input, select "ANALOG" by pressing INPUT ANALOG/DIGITAL again.

**From the remote control:**

1. Press the source selecting button (DVD, CD, TV/DBS, or TAPE/CDR)\* for which you want to change the input mode.

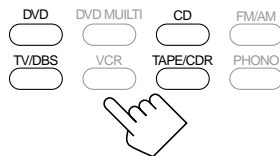

**Note:**

\* Among the sources listed above, you can select the digital input only for the sources which you have selected the digital input terminals for. (See "Digital Input (DIGITAL IN) Terminal Setting.")

2. Press ANALOG/DIGITAL to change the input mode.

- Each time you press the button, the input mode changes as follows:

ANALOG ←→ AUTO (Digital)



When playing a software encoded with the DTS Digital Surround, "AUTO" may not work properly. In this case, press CONTROL UP ▲/DOWN ▼ on the front panel to select "DTS." (See above.)

**Note:**

You can only select "ANALOG" and "AUTO" using the remote control.

## Storing the Basic Settings and Adjustments

You can assign and store different sound settings for each different playing source. By using this function, you do not have to change the settings every time you change the source. The stored settings for the newly selected source are automatically recalled.

The following can be stored for each source:

- Bass boost (see page 12)
- Tone adjustment (see page 12)
- Input attenuator mode (see page 12)
- Subwoofer output level (see page 12)
- Balance (see page 13)
- DSP modes
  - Surround mode (see page 23)
  - DAP mode (see page 25)
- DVD MULTI playback mode (see page 27)

The above settings are stored automatically in the following cases:

- When you turn on the power.
- When you change the source.
- When you assign the source name.

**Notes:**

- You cannot assign and store different settings for digital input mode and analog input mode.
- The DSP modes and DVD MULTI playback mode cannot be used at the same time.
- If the source is FM or AM, you can assign a different setting for each band.

## Using the Sleep Timer

Using the Sleep Timer, you can fall asleep to music and know the receiver will turn off by itself rather than play all night.

**From the remote control ONLY:**

Press SLEEP repeatedly.

The SLEEP indicator lights up on the display, and the shut-off time changes as follows (in minutes):

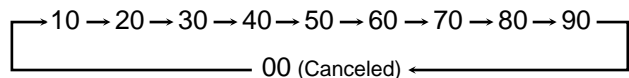

**When the shut-off time comes**

The receiver turns off automatically.

**To check or change the time remaining until the shut-off time**

Press SLEEP once.

The remaining time until the shut-off time appears in minutes.

- To change the shut-off time, press SLEEP repeatedly.

**To cancel the Sleep Timer**

Press SLEEP repeatedly until "SLEEP 00 MIN." appears on the display. (The SLEEP indicator goes off.)

- Turning off the power also cancels the Sleep Timer.

# Receiving Radio Broadcasts

You can browse through all the stations or use the preset function to go immediately to a particular station.

## Tuning in Stations Manually

### On the front panel:

#### 1. Press FM/AM to select the band (FM or AM).

The last received station of the selected band is tuned in.

- Each time you press the button, the band alternates between FM and AM.

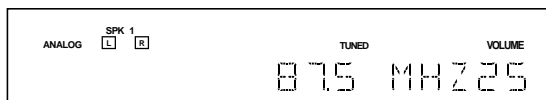
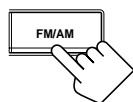

#### 2. Press FM/AM TUNING ▲/ ▼ until you find the frequency you want.

- Pressing FM/AM TUNING ▲ increases the frequency.
- Pressing FM/AM TUNING ▼ decreases the frequency.

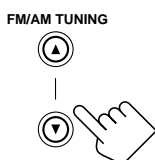

### From the remote control:

#### 1. Press FM/AM to select the band.

- Each time you press the button, the band alternates between FM and AM.



#### 2. Press TUNING +/- until you find the frequency you want.

- Pressing TUNING + increases the frequency.
- Pressing TUNING - decreases the frequency.

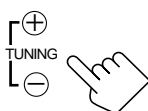

### Notes:

- When a station of sufficient signal strength is tuned in, the TUNED indicator lights up on the display.
- When an FM stereo program is received, the STEREO indicator also lights up.

## Using Preset Tuning

Once a station is assigned to a channel number, the station can be quickly tuned. You can preset up to 30 FM and 15 AM stations.

### To store the preset stations

#### Before you start, remember...

- There is a time limit in doing the following steps. If the setting is canceled before you finish, start from step 1 again.

### On the front panel ONLY:

#### 1. Tune in the station you want to preset (see "Tuning in Stations Manually").

- If you want to store the FM reception mode for this station, select the FM reception mode you want. See "Selecting the FM Reception Mode" on page 19.

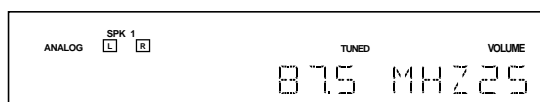

#### 2. Press MEMORY.

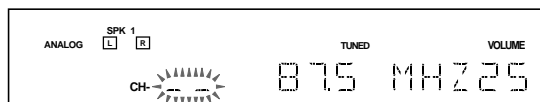
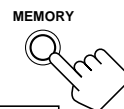

"CH-" appears and the channel number position starts flashing on the display for about 5 seconds.

#### 3. Press FM/AM PRESET ▲/ ▼ to select a channel number while the channel number position is flashing.

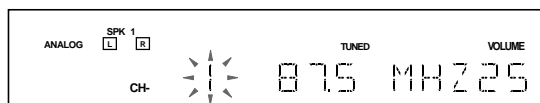
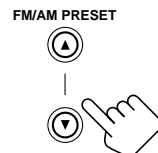

### Note:

You can use the 10 keys on the remote control to select the preset number. When using the 10 keys, be sure that they are activated for the tuner, not for the CD and others. (See page 31.)

#### 4. Press MEMORY again while the selected channel number is flashing on the display.

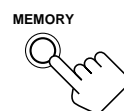

The selected channel number stops flashing.

The station is assigned to the selected channel number.

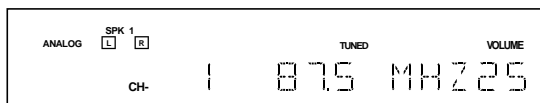

#### 5. Repeat steps 1 to 4 until you store all the stations you want.

### To erase a stored preset station

Storing a new station on a used number erases the previously stored one.

## To tune in a preset station

### On the front panel:

#### 1. Press FM/AM to select the band (FM or AM).

The last received station of the selected band is tuned in.

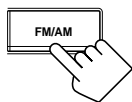

#### 2. Press FM/AM PRESET ▲/▼ until you find the channel you want.

- Pressing FM/AM PRESET ▲ increases the channel numbers.
- Pressing FM/AM PRESET ▼ decreases the channel numbers.

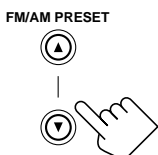

### From the remote control:

#### 1. Press FM/AM.

- Each time you press the button, the band alternates between FM and AM.



#### 2. Press the 10 keys to select a preset channel number.

- For channel number 5, press 5.
- For channel number 15, press +10 then 5.
- For channel number 20, press +10 then 10.
- For channel number 30, press +10, +10, then 10.



### Note:

When you use the 10 keys on the remote control, be sure that they are activated for the tuner, not for the CD and others. (See page 31.)

## Selecting the FM Reception Mode

### When an FM stereo broadcast is hard to receive or noisy

You can change the FM reception mode while receiving an FM broadcast.

- You can store the FM reception mode for each preset station.

### Press FM MODE on the front panel or on the remote control.

- Each time you press the button, the FM reception mode alternates between "AUTO" and "MONO."



On the front panel



On the remote control

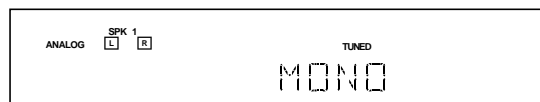
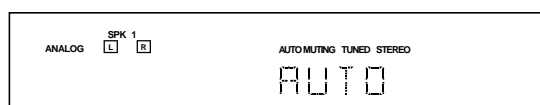

**AUTO:** When a program is broadcasted in stereo, you will hear stereo sound; when in monaural, you will hear monaural sounds. This mode is also useful to suppress static noise between stations. The AUTO MUTING indicator lights up on the display.

**MONO:** Reception will be improved although you will lose the stereo effect. In this mode, you will hear noise while tuning into the stations. The AUTO MUTING indicator goes off from the display.

### Note:

When using the FM MODE button on the remote control, be sure that the 10 keys are activated for the tuner, not for the CD and others. (See page 31.)

# Using the DSP Modes

The built-in Surround Processor provides two types of the DSP (Digital Signal Processor) mode — Surround mode and DAP (Digital Acoustic Processor) mode.

## What are the DSP Modes?

### Surround modes

With this receiver, you can use three types of the Surround mode. **Following modes cannot be used when only the front speakers are connected to this receiver (without the rear speakers or center speaker).**

### Dolby Surround (Dolby Digital and Dolby Pro Logic)\*

Used to watch the soundtracks of software encoded with Dolby Digital (bearing the mark ) or with Dolby Surround (bearing the mark .

Dolby Surround encoding format records the left front channel, right front channel, center channel, and rear channel (total 4 channels) signals into 2 channels. The Dolby Pro Logic decoder built in this receiver decodes these 2 channel signals into original 4 channel signals — matrix-based multichannel reproduction, and allows you to enjoy the realistic stereo sounds in your listening room.

On the other hand, Dolby Digital encoding method (so called discrete 5.1 channel digital audio format) records and compresses the left front channel, right front channel, center channel, left rear channel, right rear channel, and LFE channel (total 6 channels, but LFE channel is counted as 0.1 channel, therefore called 5.1 channels) signals digitally. Each channel is completely independent from other channel signals to avoid interference, therefore, you can obtain much better sound quality with much stereo and surround effects.

The Dolby Digital decoder built in this receiver can create much more realistic sound field in your listening room. You may feel as if you were in a real theater.

In addition, Dolby Digital enables stereo rear sounds, and sets the cutoff frequency of the rear treble at 20 kHz, compared to 7 kHz for Dolby Pro Logic. These facts enhance the sound movement and being-there feelings much more than Dolby Pro Logic.

- To enjoy the software encoded with Dolby Digital, you must connect the source component using the digital terminal on the rear of this receiver. (See page 8.)

### DTS Digital Surround\*\*

DTS Digital Surround is another discrete 5.1 channel digital audio format available on CD, LD, and DVD software.

Compared to Dolby Digital, audio compression rate is relatively low. This fact allows DTS Digital Surround format to add breadth and depth to the reproduced sounds. As a result, DTS Digital Surround features natural, solid and clear sound.

- To enjoy the software encoded with DTS Digital Surround, you must connect the source component using the digital terminal on the rear of this receiver. (See page 8.)

### JVC Theater Surround

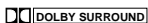
In order to reproduce a more realistic sound field in your listening room while playing soundtracks of software encoded with Dolby Surround (bearing the mark ) , you can use JVC Theater Surround.

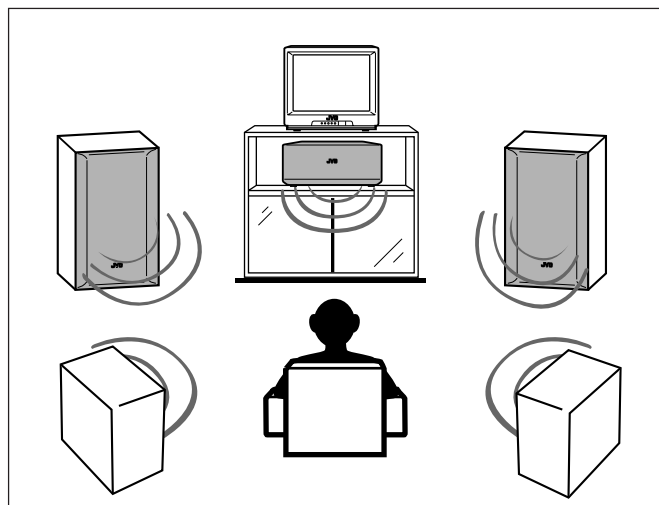

### Notes:

- The DSP modes have no effect on monaural sources.
- When you select "DVD MULTI" as the source to play, you cannot select or adjust the DSP modes.
- The PRO LOGIC indicator lights up when the Dolby Pro Logic decoder built in this receiver is activated.

\* Manufactured under license from Dolby Laboratories. "Dolby," "Pro Logic," and the double-D symbol are trademarks of Dolby Laboratories. Confidential Unpublished Works. ©1992–1997 Dolby Laboratories, Inc. All rights reserved.

\*\* Manufactured under license from Digital Theater Systems, Inc. US Pat. No. 5,451,942 and other world-wide patents issues and pending. "DTS" and "DTS Digital Surround" are trademarks of Digital Theater Systems, Inc. ©1996 Digital Theater Systems, Inc. All rights reserved.

## DAP modes

In order to reproduce a more acoustic sound field in your listening room while playing soundtracks of stereo sources, you can use DAP modes. **This mode can be used when the front speakers and the rear speakers are connected to this receiver (without respect to the center speaker connection).**

You can select one of the following to your preference.

**LIVE CLUB:** Gives the feeling of a live music club with a low ceiling.

**DANCE CLUB:** Gives a throbbing bass beat.

**HALL:** Gives clear vocal and the feeling of a concert hall.

**PAVILION:** Gives the spacious feeling of a pavilion with a high ceiling.

### DVD MULTI Playback Mode

This receiver provides the DVD MULTI playback mode for reproducing the analog discrete 5.1 channel output mode of the DVD player or other equipment.

You can adjust the DVD MULTI playback mode while playing back a video software such as a DVD using the analog discrete 5.1 channel output mode.

- For the DVD MULTI playback mode connection, see page 7.
- For details on the DVD MULTI playback mode, see page 27.

## Reproducing the Sound Field

The sound heard in a concert hall or club consists of direct sound and indirect sound — early reflections and reflections from behind. Direct sounds reach the listener directly without any reflection. On the other hand, indirect sounds are delayed by the distances of the ceiling and walls. These direct sounds and indirect sounds are the most important elements of the acoustic surround effects.

JVC Theater Surround and DAP modes can create these important elements, and give you a real “being there” feeling.

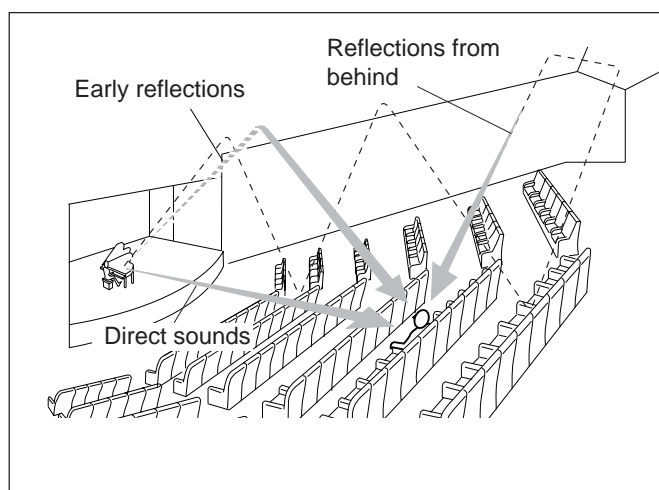

### Available DSP modes according to the input mode

○: Possible    ×: Impossible

BUTTON		SURROUND ON/OFF	DSP MODE					
MODE		SURROUND ON	THEATER	LIVE CLUB	DANCE CLUB	HALL	PAVILION	DSP OFF (SURROUND OFF)
INPUT	ANALOG (2 CH)	○ (DOLBY PRO LOGIC)	○	○	○	○	○	○
	DVD MULTI (ANALOG 5.1 CH)	×	×	×	×	×	×	×
	LINEAR PCM	○ (DOLBY PRO LOGIC)	○	○	○	○	○	○
	DOLBY DIGITAL	○ <sup>*1</sup> (DOLBY DIGITAL)	×	×	×	×	×	○
	DTS	○ <sup>*2</sup> (DTS SURROUND)	×	×	×	×	×	○

\*1 When 2 channel signal comes in, DOLBY PRO LOGIC is selected. When other signals come in, DOLBY DIGITAL is selected.

\*2 When 2 channel signal comes in, DOLBY PRO LOGIC is selected. When other signals come in, DTS SURROUND is selected.



## Available DSP Modes According to the Speaker Arrangement

Available DSP modes will vary depending on how many speakers are used with this receiver.

**Make sure that you have set the speaker information correctly (see page 14).**

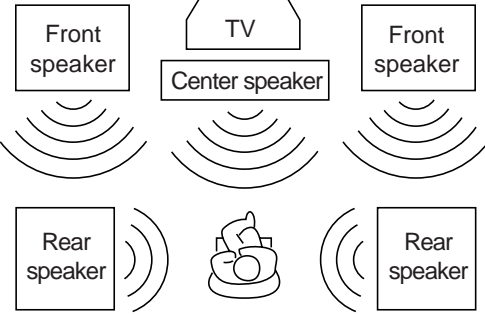
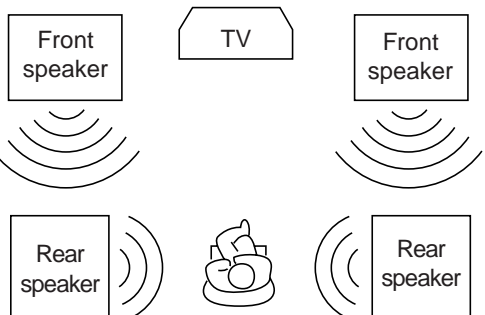
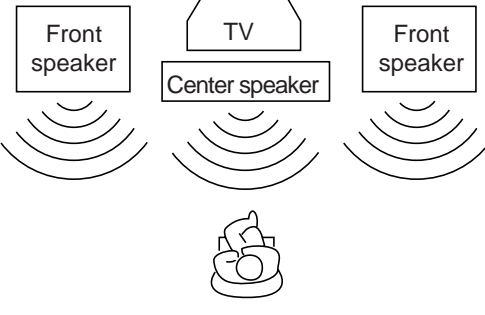
Speaker arrangements	Available DSP modes	
 <p>Diagram showing a 5.1 speaker setup: two front speakers, a center speaker, and two rear speakers, with a TV positioned above the center speaker.</p>	<p><b>By pressing SURROUND ON/OFF</b>, the surround mode turns on and off:</p> <ul style="list-style-type: none"> <li>• SURROUND ON (PRO LOGIC, DOLBY DIGITAL or DTS SURROUND)</li> <li>• SURROUND OFF (DSP mode is canceled)</li> </ul>	<p><b>By pressing DSP MODE</b>, the DSP modes change as follows:</p> <ul style="list-style-type: none"> <li>• THEATER</li> <li>• LIVE CLUB</li> <li>• DANCE CLUB</li> <li>• HALL</li> <li>• PAVILION</li> <li>• DSP OFF (DSP mode is canceled)</li> </ul>
 <p>Diagram showing a 2.1 speaker setup: two front speakers, two rear speakers, and a TV positioned above the space between the front speakers.</p>		
 <p>Diagram showing a 4.1 speaker setup: two front speakers, a center speaker, and two rear speakers, with a TV positioned above the center speaker.</p>	<p><b>By pressing SURROUND ON/OFF</b>, the surround mode turns on and off:</p> <ul style="list-style-type: none"> <li>• SURROUND ON (PRO LOGIC, DOLBY DIGITAL or DTS SURROUND)</li> <li>• SURROUND OFF (DSP mode is canceled)</li> </ul>	<p><b>By pressing DSP MODE</b>, the DSP modes change as follows:</p> <ul style="list-style-type: none"> <li>• THEATER</li> <li>• DSP OFF (DSP mode is canceled)</li> </ul>

## Adjusting the Surround Modes

Once you have adjusted the Surround modes, the adjustment is memorized for each Surround mode.



### Dolby and DTS Surround adjustments

Before you start, remember...

- Make sure that you have set the speaker information correctly (see page 14).
- There is a time limit in doing the following steps. If the setting is canceled before you finish, start from step 3 again.
- You cannot adjust the rear speaker output levels when you have set "REAR SPK" to "NO." See page 14.
- You cannot adjust the center speaker output level when you have set "CENTER SPK" to "NO." See page 14.

#### From the remote control:

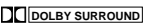
##### 1. Select and play a sound source.

- To enjoy Dolby Pro Logic, play back a software encoded with Dolby Surround and labeled with  mark.
- To enjoy Dolby Digital, play back a software encoded with Dolby Digital and labeled with  mark.
- To enjoy DTS Digital Surround, play back a software encoded with DTS Digital Surround and labeled with  mark.

##### 2. Press SURROUND ON/OFF to activate an appropriate Surround mode — PRO LOGIC, DOLBY DIGITAL or DTS SURROUND.



When "PRO LOGIC" is selected, the PRO LOGIC indicator lights up on the display.

- Each time you press the button, the Surround mode turns on and off alternately.

##### 3. Press SOUND.

The 10 keys are activated for sound adjustments.

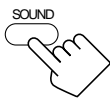

##### 4. Press TEST to check the speaker output balance.

"TEST TONE L" starts flashing on the display, and a test tone comes out of the speakers in the following order:

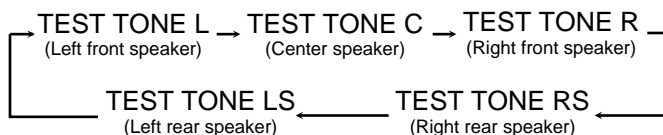
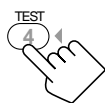

#### Notes:

- You can adjust the speaker output levels without outputting the test tone.
- No test tone comes out of the center speaker when "CENTER SPK" is set to "NO" (see page 14).
- No test tone comes out of the rear speakers when "REAR SPK" is set to "NO" (see page 14).

##### 5. Adjust the speaker output levels.

- To adjust the center speaker level, press CENTER +/- (from +10 dB to -10 dB).
- To adjust the left rear speaker level, press REAR•L +/- (from +10 dB to -10 dB).
- To adjust the right rear speaker level, press REAR•R +/- (from +10 dB to -10 dB).

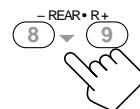
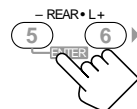
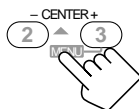



##### 6. Press TEST again to stop the test tone.



#### On the front panel:

You can also use the buttons on the front panel to adjust the Surround modes. However, no test tone is available when using the buttons on the front panel. So, make adjustments while listening to the sound of the source played back.

##### 1. Select and play a sound source.

- To enjoy Dolby Pro Logic, play back a software encoded with Dolby Surround and labeled with  mark.
- To enjoy Dolby Digital, play back a software encoded with Dolby Digital and labeled with  mark.
- To enjoy DTS Digital Surround, play back a software encoded with DTS Digital Surround and labeled with  mark.

##### 2. Press SURROUND ON/OFF to activate an appropriate Surround mode — PRO LOGIC, DOLBY DIGITAL or DTS SURROUND.

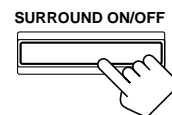

When "PRO LOGIC" is selected, the PRO LOGIC indicator lights up on the display.

- Each time you press the button, the Surround mode turns on and off alternately.

##### 3. Adjust the speaker output levels.

- 1) Press ADJUST repeatedly until one of the following indications appears on the display.

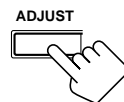

"CENTER LEVEL":

To adjust the center speaker level.

"REAR L LEVEL":

To adjust the left rear speaker level.

"REAR R LEVEL":

To adjust the right rear speaker level.

- 2) Press CONTROL UP ▲/DOWN ▼ to adjust the selected speaker output level (from +10 dB to -10 dB).

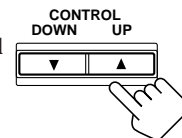

- 3) Repeat 1) and 2) to adjust the other speaker output levels.

## JVC Theater Surround adjustments

Before you start, remember...

- Make sure that you have set the speaker information correctly (see page 14).
- There is a time limit in doing the following steps. If the setting is canceled before you finish, start from step 2 again.
- You cannot adjust the rear speaker output levels when you have set "REAR SPK" to "NO." See page 14.
- You cannot adjust the center speaker output level when you have set "CENTER SPK" to "NO." See page 14.

### From the remote control:

1. Press **DSP MODE** repeatedly until "THEATER" appears on the display.

The PRO LOGIC and DSP indicators also light up on the display.

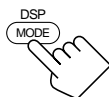

2. Press **SOUND**.

The 10 keys are activated for sound adjustments.

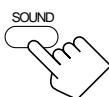

3. Press **TEST** to check the speaker output balance.

"TEST TONE L" starts flashing on the display, and a test tone comes out of the speakers in the following order:

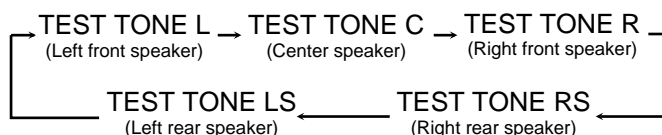
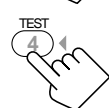

#### Notes:

- You can adjust the speaker output levels without outputting the test tone.
  - No test tone comes out of the center speaker when "CENTER SPK" is set to "NO" (see page 14).
  - No test tone comes out of the rear speakers when "REAR SPK" is set to "NO" (see page 14).
4. Adjust the speaker output levels.
    - To adjust the center speaker level, press CENTER +/- (from +10 dB to -10 dB).
    - To adjust the left rear speaker level, press REAR•L +/- (from +10 dB to -10 dB).
    - To adjust the right rear speaker level, press REAR•R +/- (from +10 dB to -10 dB).

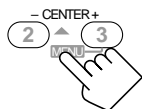

5. Press **TEST** again to stop the test tone.

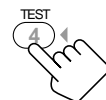

6. Press **EFFECT** to select an effect level you want.

- Each time you press the button, the effect level changes as follows:

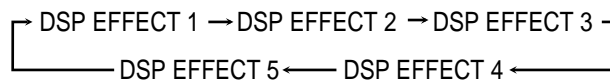
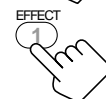

As the number increases, JVC Theater Surround becomes stronger (normally set it to "DSP EFFECT 3").

### On the front panel:

You can also use the buttons on the front panel to adjust the Surround modes. However, no test tone is available when using the buttons on the front panel. So, make adjustments while listening to the sound of the source played back.

1. Press **DSP MODE** repeatedly until "THEATER" appears on the display.

The PRO LOGIC and DSP indicators also light up on the display.

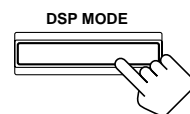

2. Adjust the speaker output levels.

- 1) Press **ADJUST** repeatedly until one of the following indications appears on the display.

"CENTER LEVEL":

To adjust the center speaker level.

"REAR L LEVEL":

To adjust the left rear speaker level.

"REAR R LEVEL":

To adjust the right rear speaker level.

- 2) Press **CONTROL UP ▲/DOWN ▼** to adjust the selected speaker output level (from +10 dB to -10 dB).

- 3) Repeat 1) and 2) to adjust the other speaker output levels.

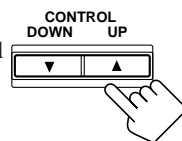
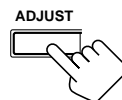

3. Adjust the effect level.

- 1) Press **ADJUST** repeatedly until "DSP EFFECT" appears on the display.

The display changes to show the current setting.

- 2) Press **CONTROL UP ▲/DOWN ▼** to select the effect level.

- Each time you press the button, the effect level changes as follows:

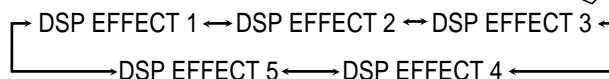
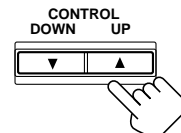
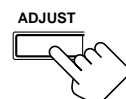

As the number increases, JVC Theater Surround becomes stronger (normally set it to "DSP EFFECT 3").

## Adjusting the DAP Modes

Once you have adjusted the DAP modes, the adjustment is memorized for each DAP mode.

Before you start, remember...

- Make sure that you have set the speaker information correctly (see page 14).
- There is a time limit in doing the following steps. If the setting is canceled before you finish, start from step 1 again.
- You cannot adjust the rear speaker output level when you have set "REAR SPK" to "NO." See page 14.

**On the front panel:**

1. Press **DSP MODE** repeatedly until the DAP mode — **LIVE CLUB, DANCE CLUB, HALL, or PAVILION** — appears on the display.

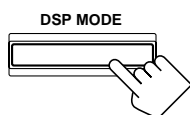

The DSP indicator also lights up on the display.

2. Adjust the rear speaker output levels.

- 1) Press **ADJUST** repeatedly until one of the following indications appears on the display.

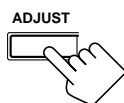

"REAR L LEVEL":

To adjust the left rear speaker level.

"REAR R LEVEL":

To adjust the right rear speaker level.

- 2) Press **CONTROL UP ▲/DOWN ▼** to adjust the selected speaker output level (from +10 dB to -10 dB).

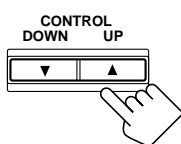

- 3) Repeat 1) and 2) to adjust the other speaker output level.

3. Adjust the effect level.

- 1) Press **ADJUST** repeatedly until "DSP EFFECT" appears on the display.

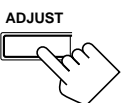

The display changes to show the current setting.

- 2) Press **CONTROL UP ▲/DOWN ▼** to select the effect level.

- Each time you press the button, the effect level changes as follows:

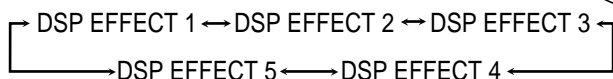
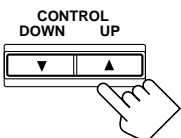

As the number increases, the selected DAP mode becomes stronger (normally set it to "DSP EFFECT 3").

**From the remote control:**

1. Press **DSP MODE** repeatedly until the DAP mode — **LIVE CLUB, DANCE CLUB, HALL, or PAVILION** — appears on the display.



The DSP indicator also lights up on the display.

2. Press **SOUND**.

The 10 keys are activated for sound adjustments.

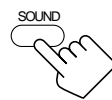

3. Adjust the rear speaker output levels.

- To adjust the left rear speaker level, press **REAR•L +/-** (from +10 dB to -10 dB).
- To adjust the right rear speaker level, press **REAR•R +/-** (from +10 dB to -10 dB).

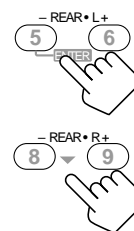

4. Press **EFFECT** to select an effect level you want.

- Each time you press the button, the effect level changes as follows:

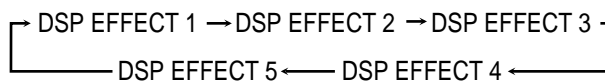
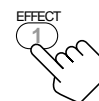

As the number increases, the selected DAP mode becomes stronger (normally set it to "DSP EFFECT 3").

## Activating the DSP Modes

You can use only one DSP mode at a time. When a DSP mode is activated, another DSP mode is canceled if in use.

### For Dolby Pro Logic, Dolby Digital, and DTS Digital Surround

#### 1. Press SURROUND ON/OFF.

- Each time you press the button, the Dolby/DTS Surround turns on and off alternately.

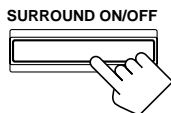



On the front panel

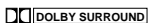

On the remote control

#### 2. Select and play a sound source.

- To enjoy Dolby Pro Logic, play back a software encoded with Dolby Surround and labeled with  mark.
- To enjoy Dolby Digital, play back a software encoded with Dolby Digital and labeled with  mark.
- To enjoy DTS Digital Surround, play back a software encoded with DTS Digital Surround and labeled with  mark.

### To cancel the Dolby/DTS Surround mode

Press SURROUND ON/OFF again. (“SURROUND OFF” appears on the display.)

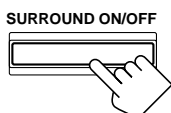

On the front panel



On the remote control

### For the other DSP modes

#### 1. Press DSP MODE repeatedly until the mode you want appears on the display.

- Each time you press the button, the DSP modes change. (See page 22 for more details.)

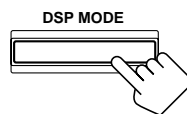

On the front panel



On the remote control

#### 2. Select and play a sound source.

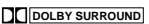
- To enjoy JVC Theater Surround, play back a software encoded with Dolby Surround and labeled with  mark.

### To cancel the DSP mode

Press DSP MODE repeatedly until “DSP OFF” appears on the display.

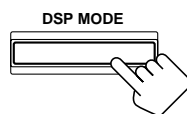

On the front panel

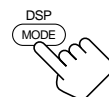

On the remote control

# Using the DVD MULTI Playback Mode

This receiver provides the DVD MULTI playback mode for reproducing the analog discrete output mode of the DVD player. Before playing back a DVD, refer also to the manual supplied with the DVD player.

## Activating the DVD MULTI Playback Mode

You can adjust the DVD MULTI playback mode while playing back a DVD using the analog discrete output mode on the DVD player. Once you have made adjustments, the receiver memorizes the adjustments until you change them. You also need to set the DVD player to the analog discrete output mode.

### Before you start, remember...

- There is a time limit in doing the following steps. If the setting is canceled before you finish, start from step 1 again.

### On the front panel:

1. Press DVD MULTI so that “DVD MULTI” appears on the display.



#### Note:

When you select “DVD MULTI” as the source to play, the DSP mode is canceled, and the SURROUND ON/OFF and DSP MODE buttons do not work.

2. Select the analog discrete output mode on the DVD player, and start playing a DVD.

- Refer to the manual supplied with the DVD player.

If you need to make any adjustment, go to the following steps.

3. Adjust the speaker output levels.

- 1) Press ADJUST repeatedly until one of the following indications appears on the display.

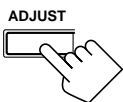

“CENTER LEVEL”:

To adjust the center speaker level.

“REAR L LEVEL”:

To adjust the left rear speaker level.

“REAR R LEVEL”:

To adjust the right rear speaker level.

- 2) Press CONTROL UP ▲/DOWN ▼ to adjust the selected speaker output level (from +10 dB to -10 dB).

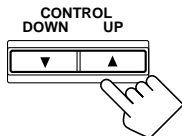

- 3) Repeat 1) and 2) to adjust the other speaker output levels.

### From the remote control:

1. Press DVD MULTI so that “DVD MULTI” appears on the display.



#### Note:

When you select “DVD MULTI” as the source to play, the DSP mode is canceled, and the SURROUND ON/OFF and DSP MODE buttons do not work.

2. Select the analog discrete output mode on the DVD player, and start playing a DVD.

- Refer to the manual supplied with the DVD player.

If you need to make any adjustment, go to the following steps.

3. Press SOUND.

The 10 keys are activated for adjusting the sound.

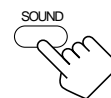

4. Adjust the speaker output levels.

- To adjust the center speaker level, press CENTER +/- (from +10 dB to -10 dB).
- To adjust the left rear speaker level, press REAR•L +/- (from +10 dB to -10 dB).
- To adjust the right rear speaker level, press REAR•R +/- (from +10 dB to -10 dB).

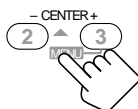

# COMPU LINK Remote Control System

The COMPU LINK remote control system allows you to operate JVC audio components through the remote sensor on the receiver.

To use this remote control system, you need to connect JVC audio components through the COMPU LINK (SYNCHRO) jacks (see below) in addition to the connections using cables with RCA pin plugs (see pages 5 and 6).

- Make sure that the AC power cords of these components are unplugged before connection. Plug the AC power cords only after all connections are complete.

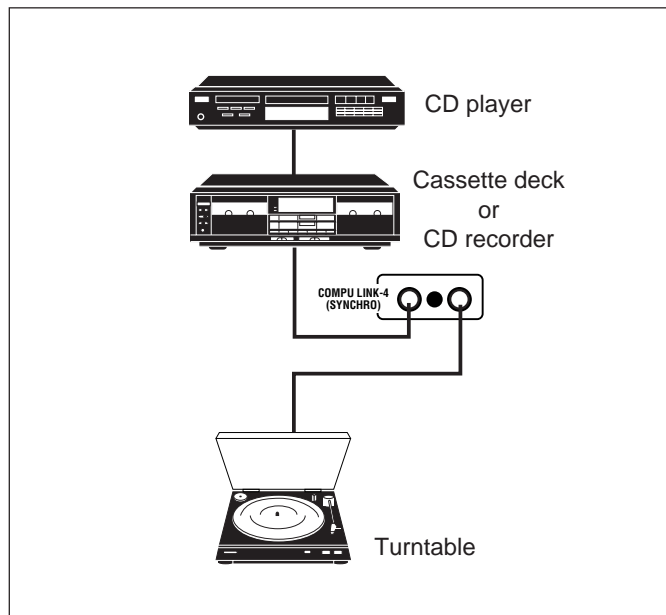

## Notes:

- There are four versions of COMPU LINK remote control system. This receiver is equipped with the fourth version — COMPU LINK-4. This version is added systematic operations with the CD recorder to the previous version — COMPU LINK-3.
- If your audio component has two COMPU LINK jacks, you can use either one. If it has only one COMPU LINK jack, connect it so that it is the last item in the series of components. (For example, the turntable or CD player in the diagram above.)
- To operate the cassette deck or CD recorder using the COMPU LINK remote control system, set the source name correctly. (See page 13.)
- Refer also to the manuals supplied with your audio components.

This remote control system allows you to use four functions listed below.

## Remote Control through the Remote Sensor on the Receiver

You can control the connected audio components through the remote sensor on the receiver using this remote control. Aim the remote control directly at the remote sensor on the receiver. For details, see pages 31 and 32.

## Automatic Source Selection

When you press the play (▶) button on a connected component or on its own remote control, the receiver automatically turns on and changes the source to the component. On the other hand, if you select a new source on the receiver or on the remote control, the selected component begins playing immediately.

In both cases, the previously selected source continues playing without sound for a few seconds.

## Automatic Power On/Off (Standby): only possible with the COMPU LINK-3 and COMPU LINK-4 connection

The connected components turn on and off (standby) along with the receiver.

When you turn on the receiver, one of the connected component will turn on automatically, depending on which component has been previously selected.

When you turn off the receiver, the connected components will turn off (standby).

## Synchronized Recording

Synchronized recording means the cassette deck starts recording as soon as a CD begins playing.

To use synchronized recording, follow these steps:

1. Put a tape in the cassette deck, and a disc in the CD player.

2. Press the record (●) button and the pause (II) button on the cassette deck at the same time.

This puts the cassette deck into recording pause.

If you do not press the record (●) button and pause (II) button at the same time, the synchronized recording feature will not operate.

3. Press the play (▶) button on the CD player.

The source changes on the receiver, and as soon as play starts, the cassette deck starts recording. When the play ends, the cassette deck enters recording pause, and stops about 4 seconds later.

## Notes:

- During synchronized recording, the selected source cannot be changed.
- If the power of any component is shut off during synchronized recording, the COMPU LINK remote control system may not operate properly. In this case, you must start again from the beginning.

# AV COMPU LINK Remote Control System

The AV COMPU LINK remote control system allows you to operate JVC video components (TV, VCR, and DVD player) through the receiver.

To use this remote control system, you need to connect the video components you want to operate, following the diagrams below and the procedure on the next page.

## CONNECTIONS 1:

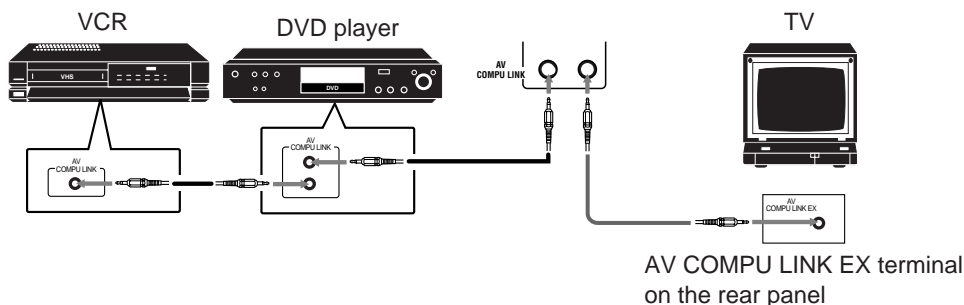

### CAUTION:

The AV COMPU LINK remote control system cannot control the DBS tuner connected to the TV SOUND/DBS jacks.

### Notes:

- When connecting only the VCR and DVD player to this receiver, connect it directly to the receiver using cable with the monaural mini-plugs.
- You can only connect the TV with AV COMPU LINK EX to the AV COMPU LINK terminal.
- Refer also to the manuals supplied with your video components.

## CONNECTIONS 2:

**CASE1:** If the components are equipped with the S-video terminals

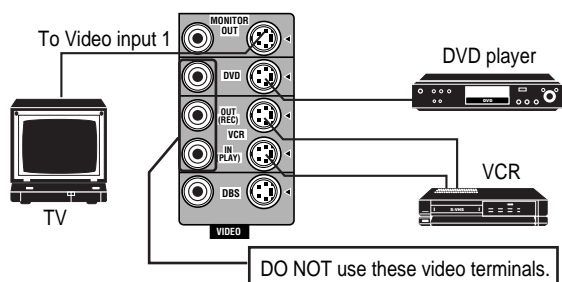

**CASE2:** If the components are not equipped with the S-video terminals

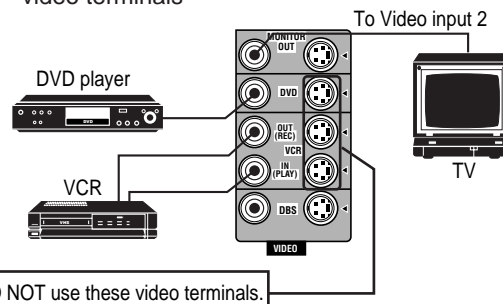

**CASE3:** If only the VCR is equipped with the S-video terminal

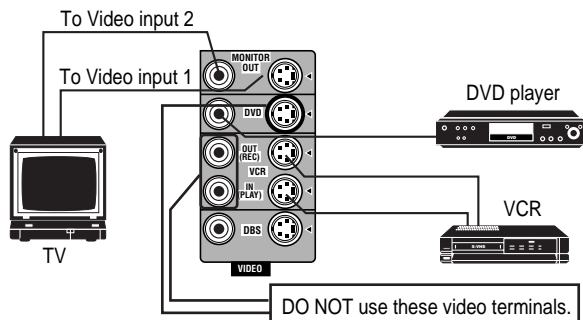

**CASE4:** If only the DVD player is equipped with the S-video terminal

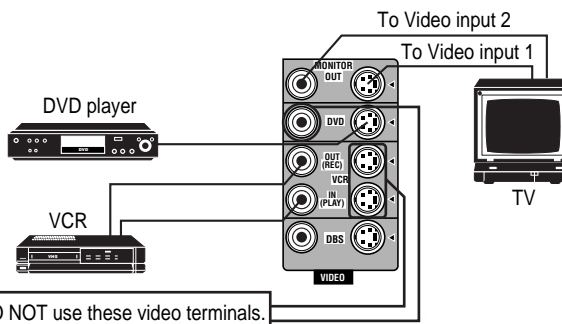



1. **If you have already plugged your VCR, DVD player, TV, and this receiver into the AC outlets, unplug their AC power cords first.**
2. **Connect your VCR, DVD player, TV, and this receiver as follows, using the cables with the monaural mini-plugs (not supplied).**
  - See “CONNECTIONS 1” on the previous page.
3. **Connect the audio input/output jacks on VCR, DVD player, TV, and this receiver using the cables with RCA pin plug.**
  - See pages 6 and 7.
4. **Connect the video input/output jacks on VCR, DVD player, TV, and this receiver using the cables with RCA pin plug or with S-video plug.**
  - See “CONNECTIONS 2” on the previous page.
5. **Plug the AC power cords of the components into the AC outlets.**
6. **When turning on the TV for the first time after the AV COMPU LINK connection, turn the TV volume to the minimum using the TV volume control on the TV.**
7. **Turn on the other connected components first, then turn on this receiver.**
  - When turning on the VCR, use the remote control supplied with this receiver (press VCR POWER).

The AV COMPU LINK remote control system allows you to use the five basic functions listed below.

#### **Remote Control of the TV, DVD player, and VCR Using This Remote Control**

See page 33 for details.

##### **For the DVD player and the VCR:**

- Aim the remote control directly at **the remote sensor on each component.**

##### **For the TV having AV COMPU LINK EX terminal:**

- Aim the remote control directly at **the remote sensor on the TV.**

#### **One-Touch Video Play**

Simply by inserting a video cassette without its safety tab into the VCR, you can enjoy the video playback without setting other switches manually. The receiver automatically turns on and changes the source to “VCR.”

The TV automatically turns on and changes the input mode to the position so that you can view the playback picture.

When you insert a video cassette with its safety tab, press the play (▶) button on the VCR or on the remote control. So, you can get the same result.

#### **One-Touch DVD Play**

Simply by starting playback on the DVD player, you can enjoy the DVD playback without setting other switches manually.

- *When the DVD player is connected through the analog input jacks on this receiver (and analog input is selected), the receiver automatically turns on and changes the source to “DVD” or “DVD MULTI.”*
- *When the DVD player is connected through the digital input terminal on this receiver (and digital input is selected), the receiver automatically turns on and changes the source to “DVD DIGITAL.”*

The TV automatically turns on and changes the input mode to the position so that you can view the playback picture.

#### **Automatic Selection of TV's Input Mode**

- When you select “TV SOUND” (or “TV DIGITAL”) as the source to play on the receiver, the TV automatically changes the input mode to the TV tuner so that you can watch TV.
- When you select “DVD” (or “DVD DIGITAL”), “DVD MULTI,” “VCR,” or “DBS” (or “DBS DIGITAL”) as the source to play on the receiver, the TV automatically changes the input mode to the appropriate position (either Video Input 1 or Video Input 2) so that you can view the playback picture.

#### **Note:**

*When you select “TV SOUND” (or “TV DIGITAL”) as the source on the receiver, you cannot see the menu on the TV screen since the AV COMPU LINK remote control system automatically changes the TV's input mode to the TV tuner.*

*If you do not mind stopping listening to the TV sounds, you can then show the on-screen displays after changing the TV's input mode to the appropriate position (either Video Input 1 or Video Input 2) the receiver is connected to.*

#### **Automatic Power On/Off**

The TV, VCR, and DVD player turn on and off along with the receiver.

When you turn on the receiver;

- If the previously selected source is “VCR,” the TV and VCR will turn on automatically.
- If the previously selected source is “TV SOUND” (or “TV DIGITAL”) or “DBS” (or “DBS DIGITAL”), only the TV will turn on automatically.
- If the previously selected source is “DVD” (or “DVD DIGITAL”) or “DVD MULTI,” the TV and DVD player will turn on automatically.

When you turn off the receiver, the TV, VCR and the DVD player will turn off.

#### **Note:**

*If you turn off the receiver while recording on the VCR, the VCR will not turn off, but continue recording.*

# Operating JVC's Audio/Video Components

You can operate JVC's audio and video components with this receiver's remote control, since control signals for JVC components are preset in the remote control.

## Operating Audio Components

### IMPORTANT:

To operate JVC's audio components using this remote control:

- You need to connect JVC audio components through the COMPU LINK (SYNCHRO) jacks (see page 28) in addition to the connections using cables with RCA pin plugs (see pages 5 and 6).
- Aim the remote control directly at the remote sensor on the receiver.
- If you use the buttons on the front panel, the remote control will not operate that source. To operate a source with the remote control, the source must be selected using source selecting buttons on the remote control.
- To operate the cassette deck or CD recorder using the COMPU LINK remote control system, set the source name correctly. (See page 13.)
- Refer also to the manuals supplied with your components.

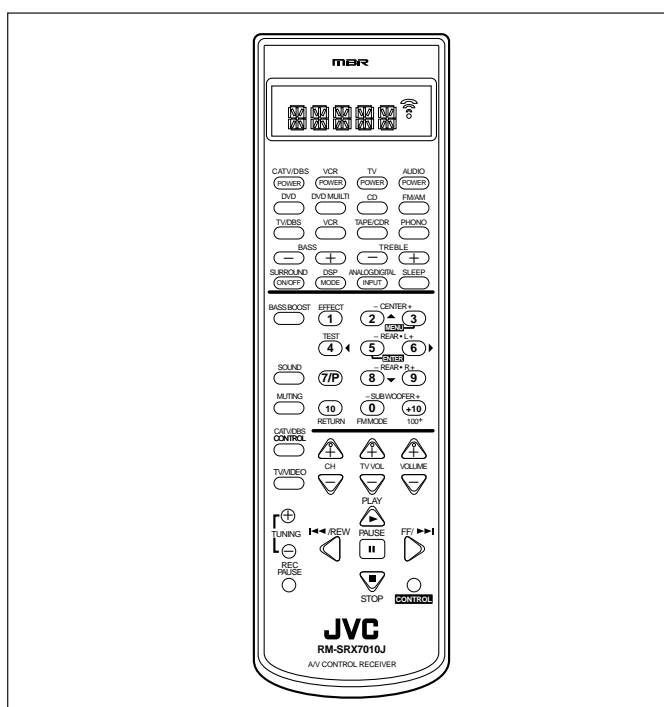

\* When you press one of the following buttons, the remote control operation mode appears on the display window for about 10 seconds.

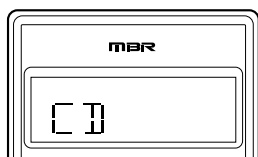

Ex.: When you press CD button

Buttons on the Remote Control	Remote Control Operation Mode
FM/AM	TUNER
CD	CD
PHONO	PHONO
TAPE/CDR	TAPE
DVD	DVD
DVD MULTI	DVD
TV/DBS	TV
VCR	VCR
CATV/DBS CONTROL	DBS
CONTROL	Current setting or VCR or TAPE or CDDSC
SOUND	SOUND

### Tuner

You can always perform the following operations:

FM/AM: Alternates between FM and AM.

After pressing FM/AM, you can perform the following operations:

1 – 10, +10: Selects a preset channel number directly.  
For channel number 5, press 5.  
For channel number 15, press +10, then 5.  
For channel number 20, press +10, then 10.

TUNING +/-: Tunes into stations.

FM MODE: Changes the FM reception mode.

### Sound control section (Amplifier)

You can always perform the following operations:

SURROUND ON/OFF: Turns on or off the Surround modes – Dolby Pro Logic, Dolby Digital, and DTS Digital Surround.

DSP MODE: Selects the DSP modes.

After pressing SOUND, you can perform the following operations:

SUBWOOFER +/-: Adjusts the subwoofer output level.

CENTER +/-: Adjusts the center speaker output level.

REAR•L +/-: Adjusts the left rear speaker output level.

REAR•R +/-: Adjusts the right rear speaker output level.

EFFECT: Selects the effect level.

TEST: Turns on or off the test tone output.

### Note:

After adjusting sounds, press the corresponding source selecting button to operate your target source by using the 10 keys; otherwise, the 10 keys cannot be used for operating your target source.

### CD player

After pressing CD, you can perform the following operations on the CD player:

PLAY▶: Starts playing.

◀◀: Returns to the beginning of the current (or previous) track.

▶▶: Skips to the beginning of the next track.

STOP■: Stops playing.

PAUSE■: Pauses playing. To release it, press PLAY▶.

1 – 10, +10: Selects a track number directly.  
For track number 5, press 5.  
For track number 15, press +10, then 5.  
For track number 20, press +10, then 10.  
For track number 30, press +10, +10, then 10.

**CD changer**

After pressing CONTROL repeatedly until “CDDSC” appears on the display window, you can perform the following operations on the CD changer:

- PLAY▶: Starts playing.
- ◀◀: Returns to the beginning of the current (or previous) track.
- ▶▶: Skips to the beginning of the next track.
- STOP■: Stops playing.
- PAUSE▬: Pauses playing. To release it, press PLAY▶.
- 1 – 6, 7/P: Selects the number of a disc installed in a CD changer.

After pressing CD, you can perform the following operations on the CD changer:

- 1 – 10, +10: Selects a track number directly.  
For track number 5, press 5.  
For track number 15, press +10, then 5.  
For track number 20, press +10, then 10.  
For track number 30, press +10, +10, then 10.

**EXAMPLE:**

- Selecting disc number 4, track number 12, and starting playback.
  1. Press CONTROL repeatedly until “CDDSC” appears on the display window, then press 4.
  2. Press CD, then press +10, 2.

**If your CD changer is of 200-disc loading capability (except for XL-MC100 and XL-MC301)**

you can do the following operations using the number buttons after pressing CD.

1. **Select a disc number.**
2. **Then select a track number (always enter two digits).**
3. **Start playback.**

**EXAMPLES:**

- Selecting disc number 3, track number 2, and starting playback.  
Press 3, then, 0, 2, then PLAY▶.
- Selecting disc number 10, track number 5, and starting playback.  
Press 1, 0, then, 0, 5, then PLAY▶.
- Selecting disc number 105, track number 12, and starting playback.  
Press 1, 0, 5, then 1, 2 then PLAY▶.

**Turntable**

After pressing PHONO, you can perform the following operations on a turntable:

- PLAY▶: Starts playing.
- STOP■: Stops operations.

**Cassette deck**

After pressing TAPE/CDR (or CONTROL repeatedly until “TAPE” appears on the display window), you can perform the following operations on a cassette deck:

- PLAY▶: Starts playing.
- REW: Fast winds the tape from right to left.
- FF: Fast winds the tape from left to right.
- STOP■: Stops operations.
- PAUSE▬: Pauses playing. To release it, press PLAY▶.
- REC PAUSE: Starts recording or enters recording pause.

**CD recorder**

After pressing TAPE/CDR (or CONTROL repeatedly until “TAPE” appears on the display window), you can perform the following operations on the CD recorder:

- PLAY▶: Starts playing.
- ◀◀: Returns to the beginning of the current (or previous) track.
- ▶▶: Skips to the beginning of the next track.
- STOP■: Stops playing.
- PAUSE▬: Pauses playing. To release it, press PLAY▶.
- REC PAUSE: Starts recording or enters recording pause.

**Note:**

*You can use either TAPE/CDR button or CONTROL button to activate the buttons listed above. If you press TAPE/CDR, the playing source also changes. On the other hand, if you press CONTROL repeatedly to select “TAPE,” the playing source does not change.*

## Operating Video Components

### IMPORTANT:

To operate JVC's video components using this remote control:

- You need to connect JVC video components through the AV COMPU LINK terminals (see page 29) in addition to the connections using cables with RCA pin plugs (see pages 6 and 7).
- Some JVC VCRs can accept two types of the control signals — remote code "A" and "B." Before using this remote control, make sure that the remote control code of the VCR connected to the VCR jacks is set to code "A."
- When using the remote control:
  - For the DVD player and VCR operations, aim the remote control directly at the remote sensor on each component, not on the receiver.
  - For the TV having the AV COMPU LINK EX terminal, aim the remote control directly at the remote sensor on the TV.

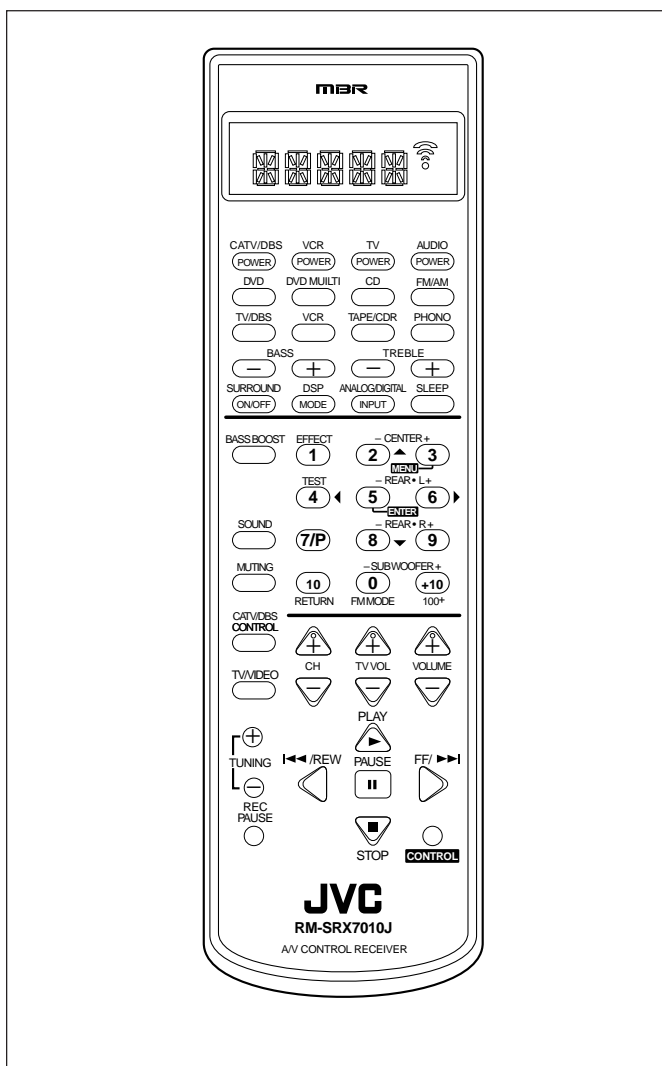

### VCR

You can always perform the following operations:

VCR POWER: Turns on or off the VCR.

After pressing VCR (or CONTROL repeatedly until "VCR" appears on the display window), you can perform the following operations on the VCR:

- 1 – 9, 0: Selects the TV channels on VCR.
- PLAY▶: Starts playing.
- REW: Rewinds a tape.
- FF: Fast winds a tape.
- STOP■: Stops operations.
- PAUSE■: Pauses playing. To release it, press PLAY▶.
- REC PAUSE: Starts recording or enters recording pause.
- CH +/-: Changes the TV channels on the VCR.

### Note:

You can use either VCR button or CONTROL button to activate the buttons listed above. If you press VCR, the playing source also changes. On the other hand, if you press CONTROL repeatedly to select "VCR," the playing source does not change.

### DVD player

After pressing DVD or DVD MULTI, you can perform the following operations on a DVD player:

- PLAY▶: Starts playing.
- ◀◀: Returns to the beginning of the current (or previous) track.
- ▶▶: Skips to the beginning of the next track.
- STOP■: Stops playing.
- PAUSE■: Stops playing temporarily. To release it, press PLAY▶.

After pressing DVD or DVD MULTI, these buttons can be used for the DVD menu operations.

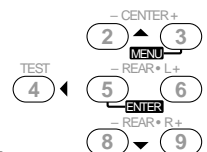

### Note:

For detailed menu operations, refer to the instructions supplied with the discs or the DVD player.

### TV

You can always perform the following operations:

- TV POWER: Turns on or off the TV.
- TV VOL +/-: Adjusts the volume.
- TV/VIDEO: Sets the input mode (either TV or VIDEO).

After pressing TV/DBS, you can perform the following operations on a TV:

- CH +/-: Changes the channels.
- 1 – 9, 0, 100+: Selects the channels.
- RETURN: Alternates between the previously selected channel and the current channel.

This remote control supplied with the receiver can transmit control signals for other manufacturers' VCRs, TVs, CATV converters, DBS tuners, and DVD players. By changing the transmittable signals from preset ones to the other manufacturers', you can operate the other manufacturer's components using this remote control.

When operating the other manufacturers' components, refer also to the manuals supplied with them. To operate these components with the remote control, first you need to set the manufacturer's code each for VCR, TV, CATV converters, DBS tuner, and DVD player.

When replacing batteries of the remote control, set the manufacturers' codes again.

## To change the transmittable signals for operating another manufacturer's TV

1. Press and hold TV POWER.
2. Press TV/DBS.
3. Enter manufacturer's code using buttons 1 – 9, and 0.

See the list below to find the code.

### 4. Release TV POWER.

The following buttons can be used for operating the TV:

- TV POWER: Turns on and off the TV.
- TV VOL +/-: Adjusts the volume.
- TV/VIDEO: Sets the input mode (either TV or VIDEO).

After pressing TV/DBS, you can perform the following operations on a TV:

- CH +/-: Changes the channels.
- 1 – 10, 0, 100+ (+10): Selects the channels. The 10 button will function as the ENTER button if your TV requires pressing ENTER after selecting a channel number.

**Note:**

Refer to the manual supplied with your TV.

### 5. Try to operate your TV by pressing TV POWER.

When your TV turns on or off, you have entered the correct code.

If there are more than one code listed for your brand of TV, try each one until the correct one is entered.

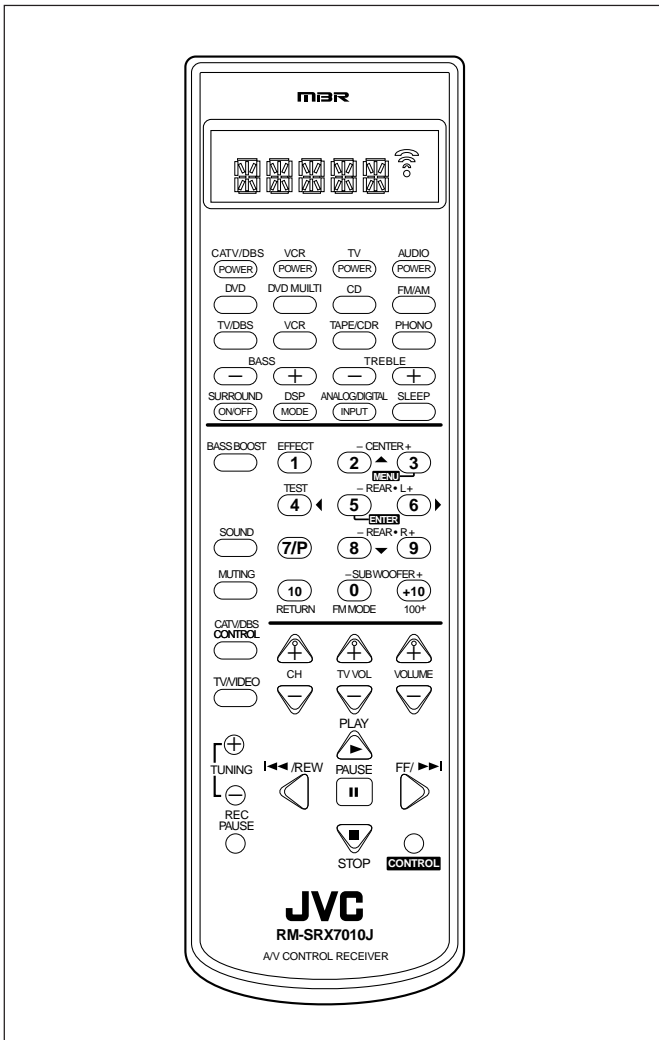

Manufacturers' codes are subject to change without notice. If they are changed, this remote control cannot operate the equipment.

Manufacturer	Codes
JVC	00, 02, 13, 14, 47, 74
AKAI	01, 02
BLAUPUNKT	03, 04
FISHER	01, 05
GRUNDIG	03, 06, 07
HITACHI	08, 09, 10, 49
IRADDIO	02
ITT/NOKIA	11, 12
LOEWE	06, 15, 16
MAGNAVOX	08, 17, 49
METS	50, 51, 52, 53
MITSUBISHI	08, 18, 19, 20
MIVAR	21
NORDMENDE	22, 23
OKANO	15
PANASONIC	24, 25, 26, 27, 76
PHILIPS	15, 17, 28, 75
QUELLE	52, 53, 54, 55, 56, 57, 58, 59, 60, 61, 62, 63, 64, 65, 66, 67
RCA/PROSCAN	08, 24, 29, 30, 31, 48
SABA	32, 33, 68, 69, 70
SAMSUNG	06, 08, 16, 34, 35, 49
SANYO	01, 05
SCHNEIDER	02, 15, 36
SHARP	37, 38, 77
SONY	39
TELEFUNKEN	40, 41, 42, 69
THOMSON	71, 72
TOSHIBA	37, 43, 44
ZENITH	45, 46

## To change the transmittable signals for operating a CATV converter or DBS tuner

1. Press and hold CATV/DBS POWER.
2. Press CATV/DBS CONTROL.
3. Enter manufacturer's code using buttons 1 – 9, and 0.  
See the list to the right to find the code.
4. Release CATV/DBS POWER.

The following buttons can be used for operating the CATV converter or DBS tuner:

CATV/DBS POWER: Turns on and off the CATV converter or DBS tuner.

CH +/-: Changes the channels.

1 – 10, 0, 100+ (+10): Selects the channels.  
The 10 button will function as the ENTER button if your equipment requires pressing ENTER after selecting a channel number.

**Note:**

Refer to the manual supplied with your CATV converter or DBS tuner.

5. Try to operate your CATV converter or DBS tuner by pressing CATV/DBS POWER.

When your CATV converter or DBS tuner turns on or off, you have entered the correct code.

**If there are more than one code listed for your brand of CATV converter or DBS tuner**, try each one until the correct one is entered.

**Note:**

You cannot use both the CATV converter and DBS tuner at the same time.

### For CATV converter

Manufacturer	Codes
GENERAL INSTRUMENT	06, 07, 08, 09, 10, 11, 12, 13, 14, 29
HAMLIN/REGAL	01, 02, 03, 04, 05
JERROLD	06, 07, 08, 09, 10, 11, 12, 13, 14
OAK	15, 16, 17
PANASONIC	18, 19, 20
PIONEER	21, 22
SCIENTIFIC ATLANTA	23, 24, 25
TOCOM	26
ZENITH	27, 28

Manufacturers' codes are subject to change without notice. If they are changed, this remote control cannot operate the equipment.

### For DBS tuner

Manufacturer	Codes
JVC	56, 57, 67
AMSTRAD	43, 44, 45, 46, 47
BLAUPUNKT	30
ECHOSTAR	50, 51, 67
GOLDSTAR	31
GRUNDIG	32, 33
HIRSHMANN	48, 52, 53, 55
INSTRUMENT	68
ITT/NOKIA	34
KATHREIN	52, 58, 61, 62, 63
NEC	35, 36
ORBITECH	48
PHILIPS	37, 38
RCA	65
SAMSUNG	39, 40
SCHWAIGER	61, 64
SIEMENS	41, 42
SONY	66
TECHNISAT	48

Manufacturers' codes are subject to change without notice. If they are changed, this remote control cannot operate the equipment.

## To change the transmittable signals for operating another manufacturer's VCR

1. Press and hold VCR POWER.
2. Press VCR.
3. Enter manufacturer's code using buttons 1 – 9, and 0.

See the list to the right to find the code.

### 4. Release VCR POWER.

The following button can be used for operating the VCR:

VCR POWER: Turns on and off the VCR.

After pressing VCR, you can perform the following operations on the VCR:

- CH +/-: Changes the TV channels on the VCR.  
 1 – 10, 0, 100+ (+10): Selects the TV channels.  
 The 10 button will function as the ENTER button if your VCR requires pressing ENTER after selecting a channel number.
- PLAY▶: Starts playback.  
 REW: Rewinds a video tape.  
 FF: Fast winds a video tape.  
 STOP■: Stops operation.  
 PAUSE⏸: Pauses.  
 REC PAUSE: Starts recording or enters recording pause.

#### **Note:**

Refer to the manual supplied with your VCR.

### 5. Try to operate your VCR by pressing VCR POWER.

When your VCR turns on or off, you have entered the correct code.

**If there are more than one code listed for your brand of VCR, try each one until the correct one is entered.**

Manufacturer	Codes
JVC	00, 26, 27, 28, 29, 58
AIWA	01, 02
BELL & HOWELL	03
BLAUPUNKT	04, 05
CGM	06, 07
EMERSON	08, 10, 11, 12, 64, 65
FISHER	03, 14, 15, 16, 17
FUNAI	01
GE	18, 19, 20
GOLDSTAR	07
GOODMANS	13, 21
GRUNDIG	06, 22
HITACHI	18, 23, 24, 25, 66
LOEWE	07, 21
MAGNAVOX	04, 19, 24
MITSUBISHI	30, 31, 32, 33, 34, 35
NEC	26, 27
NOKIA	03, 36
NORDMENDE	38
ORION	09
PANASONIC	19, 24, 39, 40
PHILIPS	04, 19, 21, 24, 41, 42
PHONOLA	21
RCA/PROSCAN	04, 18, 19, 23, 24, 43, 44, 45
SABA	38, 46
SAMSUNG	45, 47, 59, 61, 62, 63
SANYO	03, 48, 49
SHARP	37, 50
SIEMENS	03, 51
SONY	52, 53, 54
TELEFUNKEN	55, 60
TOSHIBA	43, 44
ZENITH	57

Manufacturers' codes are subject to change without notice. If they are changed, this remote control cannot operate the equipment.

## To change the transmittable signals for operating another manufacturer's DVD player

1. Press and hold **AUDIO POWER**.
2. Press **DVD**.
3. Enter manufacturer's code using buttons **1 – 9, and 0**.  
See the list to the right to find the code.
4. Release **AUDIO POWER**.

After pressing **DVD** or **DVD MULTI**, you can perform the following operations on a DVD player:

- PLAY▶**: Starts playing.  
**◀◀**: Returns to the beginning of the current (or previous) tracks.  
**▶▶**: Skips to the beginning of the next track.  
**STOP■**: Stops playing.  
**PAUSE⏸**: Stops playing temporarily. To release it, press **PLAY▶**.

Manufacturer	Codes
JVC	00, 02
DENON	01
PANASONIC	03
PHILIPS	13
PIONEER	04, 05, 06
RCA	07
SAMSUNG	08
SONY	09
TOSHIBA	10
YAMAHA	11, 12

Manufacturers' codes are subject to change without notice. If they are changed, this remote control cannot operate the equipment.

After pressing **DVD** or **DVD MULTI**, these buttons can be used for the DVD menu operations.

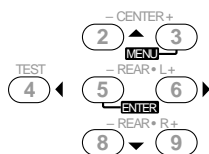

**Note:**

For detailed menu operations, refer to the instructions supplied with the discs or the DVD player.

**Note:**

Refer to the manual supplied with your DVD player.

5. Try to operate your DVD player by pressing one of the above buttons.
  - DO NOT forget to turn on the DVD player before pressing one of the above buttons.

If there are more than one code listed for your brand of DVD player, try each one until the correct one is entered.



# Troubleshooting

Use this chart to help you solve daily operational problems. If there is any problem you cannot solve, contact your JVC service center.

PROBLEM	POSSIBLE CAUSE	SOLUTION
The display does not light up.	The power cord is not plugged in.	Plug the power cord into an AC outlet.
No sound from speakers.	Speaker signal cables are not connected.	Check speaker wiring and reconnect if necessary.
	The SPEAKERS ON/OFF 1 and 2 buttons are not set correctly.	Press SPEAKERS ON/OFF 1 and 2 correctly.
	An incorrect source is selected.	Select the correct source.
	Muting is activated.	Press MUTING to cancel the mute.
	An incorrect input mode (analog or digital) is selected.	Select the correct input mode (analog or digital).
Sound from one speaker only.	Connections are incorrect.	Check connections. For analog connections, see page 5. For digital connections, see page 8.
	Speaker signal cables are not connected properly.	Check speaker wiring and reconnect if necessary.
Continuous hiss or buzzing during FM reception.	The balance is set to one extreme.	Adjust the balance properly (see page 13).
	Incoming signal is too weak.	Connect an outdoor FM antenna or contact your dealer.
	The station is too far away.	Select a new station.
	An incorrect antenna is used.	Check with your dealer to be sure you have the correct antenna.
Occasional cracking noise during FM reception.	Antennas are not connected properly.	Check connections.
Howling during record playing.	Ignition noise from automobiles.	Move the antenna farther from automobile traffic.
Noise is heard.	Your turntable is too close to speakers.	Move speakers away from the turntable.
"OVERLOAD" starts flashing on the display.	An earth (⏏) cable is not connected to the AM (⏏) terminal on the rear panel.	Connect the cable to the AM (⏏) terminal on the rear panel.
	Speakers are overloaded because of high volume.	1. Press POWER on the front panel to turn off the receiver. 2. Stop the playback source. 3. Turn on the receiver again, and adjust the volume.
"DSP MICON NG" starts flashing on the display.	Speakers are overloaded because of short circuit of speaker terminals.	Press POWER on the front panel, then check the speaker wiring. If "OVERLOAD" does not disappear, unplug the AC power cord, then plug it back again. If speaker wiring is not short-circuited, contact your dealer.
	The built-in microcomputer is not functioning correctly.	Press POWER on the front panel to turn off the receiver. After unplugging the power cord, consult your dealer.
The STANDBY lamp lights up after turning on the power, but soon the receiver turns off (into standby mode).	The receiver is overloaded because of a high voltage.	Press POWER on the front panel to turn off the receiver. After unplugging the power cord, consult your dealer.
Remote control does not work.	There is an obstruction in front of the remote sensor on the receiver.	Remove the obstruction.
	Batteries are weak.	Replace batteries.
Remote control does not operate intendedly.	An incorrect remote control operation mode is selected.	Select the correct remote control operation mode. (See page 31).

# Specifications

## Amplifier

### Output Power

At Stereo operation:

Front channels: **100 W per channel, min. RMS, driven into 8 Ω, 40 Hz to 20 kHz with no more than 0.8% total harmonic distortion.**

At Surround operation:

Front channels: 100 W per channel, min. RMS, driven into 8 Ω at 1 kHz with no more than 0.8% total harmonic distortion.

Center channel: 100 W, min. RMS, driven into 8 Ω at 1 kHz, with no more than 0.8% total harmonic distortion.

Rear channels 100 W per channel, min. RMS, driven into 8 Ω at 1 kHz, with no more than 0.8% total harmonic distortion.

## Audio

Audio Input Sensitivity/Impedance (1 kHz):	PHONO (MM):	2.7 mV/47 kΩ
	CD, TAPE/CDR, TV SOUND/DBS, VCR, DVD:	220 mV/47 kΩ
Audio Input (DIGITAL IN)* :	Coaxial: DIGITAL 1 (DVD):	0.5 V(p-p)/75 Ω
	Optical: DIGITAL 2 (CD), DIGITAL 3 (TV), DIGITAL 4 (CDR):	-21 dBm to -15 dBm (660 nm ±30 nm)

\*Corresponding to Linear PCM, Dolby Digital, and DTS Digital Surround (with sampling frequency — 32 kHz, 44.1 kHz, 48 kHz).

Audio Output Level:	TAPE/CDR, VCR:	220 mV
Digital output:	Optical: DIGITAL OUTPUT	
	Signal wave length: 660 nm	
	Output level: -21 dBm to -15 dBm	
Signal-to-Noise Ratio ('66 IHF/'78 IHF):	PHONO (MM):	70 dB/78 dB (at REC OUT)
	CD, TAPE/CDR, TV SOUND/DBS, VCR, DVD:	87 dB/67 dB
Frequency Response (8 Ω)	PHONO:	20 Hz to 20 kHz (±1 dB)
	CD, TAPE/CDR, TV SOUND/DBS, VCR, DVD:	20 Hz to 20 kHz (±1 dB)
RIAA Phono Equalization:	±1.0 dB (20 Hz to 20 kHz)	
Bass boost:	+3 dB ±1.0 dB at 100 Hz	
Tone Control:	Bass (100 Hz):	±10 dB
	Treble (10 kHz):	±10 dB

## Video

Video Input Sensitivity/Impedance:		
Composite video:	DBS, VCR, DVD:	1 V(p-p)/75 Ω
S-video:	DBS, VCR, DVD:	(Y: luminance): 1 V(p-p)/75 Ω
		(C: chrominance, burst): 0.286 V(p-p)/75 Ω
Video Output Level:		
Composite video:	VCR, MONITOR OUT:	1 V(p-p)/75 Ω
S-video:	VCR, MONITOR OUT:	(Y: luminance): 1 V(p-p)/75 Ω
		(C: chrominance, burst): 0.286 V(p-p)/75 Ω
Synchronization:	Negative	
Signal-to-Noise Ratio:	45 dB	

***FM tuner (IHF)***

Tuning Range:	87.5 MHz to 108.0 MHz	
Usable Sensitivity:	Monaural:	12.8 dBf (1.2 $\mu$ V/75 $\Omega$ )
50 dB Quieting Sensitivity:	Monaural:	21.3 dBf (3.2 $\mu$ V/75 $\Omega$ )
	Stereo:	41.3 dBf (31.5 $\mu$ V/75 $\Omega$ )
Signal-to-Noise Ratio (IHF-A weighted):	Monaural:	78 dB at 85 dBf
	Stereo:	73 dB at 85 dBf
Total Harmonic Distortion:	Monaural:	0.4% at 1 kHz
	Stereo:	0.6% at 1 kHz
Stereo Separation at REC OUT:	35 dB at 1 kHz	
Alternate Channel Selectivity:	45 dB: ( $\pm$ 400 kHz)	
Frequency Response:	30 Hz to 15 kHz: (+0.5 dB, -3 dB)	

***AM tuner***

Tuning Range:	530 kHz to 1 710 kHz	
Usable Sensitivity:	Loop antenna	400 $\mu$ V/m
Signal-to-Noise Ratio	50 dB (100 mV/m)	

***General***

Power Requirements:	AC 120V $\sim$ , 60 Hz
Power Consumption:	180 W/230 VA (at operation) 2 W (in standby mode)
Dimensions (W x H x D):	435 mm x 146.5 mm x 425.5 mm (17 <sup>3</sup> / <sub>16</sub> in. x 5 <sup>13</sup> / <sub>16</sub> in. x 16 <sup>13</sup> / <sub>16</sub> in.)
Mass:	8.6 kg (19.0 lbs)

Designs & specifications are subject to change without notice.

